

*Turbo Pascal*<sup>®</sup>

Version 5.5

---

Object-oriented programming  
guide

This manual was produced with Sprint® The Professional Word Processor

---

Copyright © 1988 by Borland International. All rights reserved. All Borland products are trademarks or registered trademarks of Borland International, Inc. Other brand and product names are trademarks or registered trademarks of their respective holders.

# C O N T E N T S

---

<b>Introduction</b>	1	Once virtual, always virtual	38
About this manual	1	An example of late binding	38
Installation	2	Procedure or method?	40
Special Notes	3	Object extensibility	47
Online help	4	Static or virtual methods	49
How to contact Borland	4	Dynamic objects	50
For further information about Turbo Pascal 5.5	5	Allocation and initialization with	
		New	51
		Disposing dynamic objects	52
		Destructors	53
		An example of dynamic object	
		allocation	55
		Disposing of a complex data structure	
		on the heap	56
		Where to now?	62
		Conclusion	63
<b>Chapter 1 All about OOP</b>	7	<b>Chapter 2 Object-oriented</b>	
Objects?	8	<b>debugging</b>	65
Inheritance	9	Object-oriented debugging in the IDE	65
Objects: Records that inherit	10	Stepping and tracing method calls	65
Instances of object types	13	Objects in the Evaluate window	66
An object's fields	13	Objects in the Watch window	66
Good practice and bad practice	13	Expressions in the Find Procedure	
Methods	14	command	66
Code and data together	15	Turbo Debugger	67
Defining methods	16	Stepping and tracing method calls	67
Method scope and the Self		Scope	67
parameter	17	Evaluate Window	68
Object data fields and method formal		Calling methods in the Evaluate	
parameters	19	window	69
Objects exported by units	19	Watch window	69
Programming in the active voice	22	The Object Hierarchy window	69
Encapsulation	23	The object type list pane	70
Methods: No downside	24	The local menu	70
Extending objects	25	The hierarchy tree pane	70
Inheriting static methods	27		
Virtual methods and polymorphism	29		
Early binding vs. late binding	31		
Object type compatibility	32		
Polymorphic objects	34		
Virtual methods	36		
Range checking virtual method			
calls	37		

The Object Type Inspector window .	71
The local menus .....	71
Object Instance Inspector window ..	72
Local menus .....	73
New error messages .....	74

### **Chapter 3 Turbo Pascal 5.5 language definition**

definition	75
New reserved words .....	75
Object types .....	75
Assignment compatibility .....	80
Object component designators .....	81
Dynamic object type variables .....	81
Instance initialization .....	81
Object type constants .....	82
@ with a method .....	83
Function calls .....	83
Assignment statements .....	83
Procedure statements .....	83
Case statements .....	84
With statements .....	84
Method declarations .....	85
Constructors and destructors .....	86
Variable parameters .....	88
Extensions to New and Dispose .....	88
Compiler directive conditional symbols .....	90

<b>Chapter 4 Overlays</b>	91
Overlay buffer management .....	91
Variables .....	94
OvrTrapCount .....	94
OvrLoadCount .....	94
OvrFileMode .....	94
OvrReadBuf .....	94
Procedures and functions .....	96
OvrSetRetry .....	97
OvrGetRetry .....	97
Overlays in .EXE files .....	97

<b>Chapter 5 Inside Turbo Pascal</b>	99
Internal data format of objects .....	99
Virtual method tables .....	100
The SizeOf standard function .....	102
The TypeOf standard function .....	103
Virtual method calls .....	103
Method calling conventions .....	104
Constructors and destructors .....	104
Assembly language methods .....	105
Constructor error recovery .....	108

<b>Appendix A New and modified error messages</b>	113
---	-----

<b>Appendix B Glossary</b>	115
----------------------------	-----

<b>Index</b>	119
--------------	-----

# F I G U R E S

---

1.1: A partial taxonomy chart of insects ..9  
1.2: Layout of program ListDemo's data  
structures ..... 56  
4.1: Loading and disposing overlays ....92

5.1: Layouts of instances of Location, Point,  
and Circle ..... 100  
5.2: Point and Circle's VMT layouts ... 102



Turbo Pascal 5.5 gives you the power and efficiency of object-oriented programming at turbo speed. In addition to the Turbo Pascal features you have come to rely on, this new version offers you the programming techniques of the future:

- both static objects for maximum efficiency and dynamic objects for maximum run-time flexibility
- both static and virtual methods
- constructors and destructors that create and deallocate objects (saves programming time and improves readability of your code)
- object constants—static object data is initialized automatically
- greater speed—Turbo Pascal 5.5 compiles faster than ever
- improved overlay manager (lets overlays run faster, with less disk I/O)
- enhanced help screens that let you cut and paste examples into your code
- an online tutorial to introduce you to Turbo Pascal's integrated development environment

The object-oriented extensions in Turbo Pascal 5.5 were inspired by Larry Tesler's *Object Pascal Report* (Apple, 1985) and Bjarne Stroustrup's *The C++ Programming Language* (Addison-Wesley, 1986).

## About this manual

---

This manual contains information on the new object-oriented features of Turbo Pascal 5.5. For all other information about Turbo Pascal, refer to the *Turbo Pascal User's Guide* or the *Turbo Pascal Reference Guide*.

Here's a breakdown of the chapters and appendixes in this volume:

- **Chapter 1: All about OOP** introduces you to the main concepts of object-oriented programming—how objects differ from records, the advantages of encapsulated data and code, inheritance, polymorphism, static versus dynamic object instances. It uses practical examples to demonstrate the principles of object-oriented programming.
- **Chapter 2: Object-oriented debugging** covers modifications to Turbo Debugger to support Turbo Pascal 5.5, including Object Inspectors and the Object Hierarchy window.
- **Chapter 3: Turbo Pascal 5.5 language definition** contains the formal definition of all object-oriented extensions to Turbo Pascal.
- **Chapter 4: Overlays** discusses improvements to the Turbo Pascal overlay manager.
- **Chapter 5: Inside Turbo Pascal** explains the implementation of the object-oriented features of Turbo Pascal 5.5.
- **Appendix A: New and modified error messages** lists new compiler error messages and warnings specific to object-oriented Turbo Pascal.

## Installation

---

The first thing you'll want to do is install Turbo Pascal on your system. Your Turbo Pascal package includes all the files and programs necessary to run both the integrated environment and command-line versions of the compiler. The `INSTALL` program sets up Turbo Pascal on your system. It works on both hard-disk and floppy-based systems.

`INSTALL` walks you through the installation process. All you have to do is follow the instructions that appear onscreen at each step. *Please read them carefully.* If you're installing on floppies, rather than on a hard disk, be sure to have at least four blank, formatted 360K disks on hand.



To run INSTALL:

-  1. Insert the distribution disk labeled Installation Disk in drive A.
- 2. Type A: and press *Enter*.
- 3. Type `INSTALL` and press *Enter*.

From this point on, just follow the instructions that `INSTALL` displays onscreen.

As soon as `INSTALL` is finished running, you are ready to start using Turbo Pascal.

-  After you've tried out the Turbo Pascal integrated development environment, you may want to customize some of the options. To do that, use the program `TINST`, which is discussed in Appendix D of the *User's Guide*.

---

## Special Notes

- If you use `INSTALL`'s Upgrade option, version 5.5 files will overwrite any version 5.0 files that have the same names.
- If you install the graphics files into a separate subdirectory (C:\TP\BGI, for example), remember to specify the full path to the driver and font files when you call `InitGraph`. For example,  

```
InitGraph(Driver, Mode, 'C:\TP\BGI');
```
- If `GRAPH.TPU` is not in the current directory, you'll need to add its location to the unit directories with the `Options/Directories/Unit Directories` command (or with the `/U` option in the command-line compiler) in order to compile a BGI program.
- If you have difficulty reading the text displayed by the `INSTALL` or `TINST` programs, they will both accept an optional command-line parameter that forces them to use black-and-white display:
  - `A:INSTALL /B` Forces `INSTALL` into BW80 mode
  - `A:TINST /B` Forces `TINST` into BW80 mode

You may need to specify the `/B` parameter if you are using an LCD screen or a system that has a color graphics adapter and a monochrome or composite monitor. To find out how to force the integrated environment to use black-and-white permanently with your LCD screen (or CGA and monochrome/composite monitor combination), see the note on page 308 of the *User's Guide*.

## Online help

---

You can get online help about both the integrated environment and language-specific items. To bring up help when you're on a menu item or within a window, press *F1*; to bring up the main index to the help system, press *F1* again.

*Language-specific help is available only when you're in the Edit window.*

For language help, position your cursor on the item in the Edit window you want to know more about, then press *Ctrl-F1*. You can get help about the syntax of Pascal reserved words or the use and parameters of a particular procedure or function, cut and paste examples into your file, find out about compiler switches, and more.

To cut and paste from help, follow these easy steps:



1. Once you've brought up the help screen you want to copy from, press *C*. This activates the cursor so you can position it anywhere on the help screen.
2. After you've placed the cursor at the beginning of the text you want to copy, press *B* to begin. Then use the *↑*, *↓*, *→*, and *←* arrow keys to move to the end of your block (highlighting the text you're copying at the same time). Pressing *B* again resets the beginning of the block to the cursor position.
3. To end cut-and-paste and to place the text in your edit file, press *Enter*.
4. The text is pasted into the editor and is marked as a block, which makes it easy for you to move it.

## How to contact Borland

---

If, after reading this manual and using Turbo Pascal, you'd like to contact Borland with comments for technical support, we suggest the following procedures:

- The best way is to log on to Borland's forum on CompuServe: Type *GO BPROGA* at the main CompuServe menu and follow the menus to section 2. Leave your questions or comments here for the support staff to process.
- If you prefer, write a letter and send it to

Technical Support Department  
Borland International  
P.O. Box 660001  
1800 Green Hills Road  
Scotts Valley, CA 95066-0001

Note! ■■■▶

If you include a program example in your letter, it must be limited to 100 lines or less. We request that you submit it on disk, include all the necessary support files on that disk, and provide step-by-step instructions on how to reproduce the problem. Before you decide to get technical support, try to duplicate the problem with the code contained on the floppy disk, just to be sure we can duplicate the problem using the disk you provide us.

- You can also telephone our Technical Support department at (408) 438-5300. To help us handle your problem as quickly as possible, have these items handy before you call:
  - product name and version number
  - product serial number
  - computer make and model number
  - operating system and version number

## For further information about Turbo Pascal 5.5

---

Borland recommends the following book/disk package:

Werner Fiebel. *Turbo Pascal DiskTutor*. Borland\*Osborne/McGraw-Hill Programming Series. Osborne/McGraw-Hill, 1989.

The package includes the Turbo Pascal DiskTutor and the Turbo Pascal 5.5 compiler.



## All about OOP

Object-oriented programming (OOP) is a method of programming that closely mimics the way all of us get things done. It is a natural evolution from earlier innovations to programming language design: It is more structured than previous attempts at structured programming; and it is more modular and abstract than previous attempts at data abstraction and detail hiding. Three main properties characterize an object-oriented programming language:

- *Encapsulation*: Combining a record with the procedures and functions that manipulate it to form a new data type—an object.
- *Inheritance*: Defining an object and then using it to build a hierarchy of descendant objects, with each descendant inheriting access to all its ancestors' code and data.
- *Polymorphism*: Giving an action one name that is shared up and down an object hierarchy, with each object in the hierarchy implementing the action in a way appropriate to itself.

Turbo Pascal 5.5's language extensions give you the full power of object-oriented programming: more structure and modularity, more abstraction, and reusability built right into the language. All these features add up to code that is more structured, extensible, and easy to maintain.

The challenge of object-oriented programming is that it requires you to set aside habits and ways of thinking about programming that have been considered standard for many years. Once you do that, however, OOP is a simple, straightforward, and superior tool

for solving many of the problems that plague traditional software programs.

*A note to you who have done object-oriented programming in other languages:* Put aside your previous impressions of OOP and learn Turbo Pascal 5.5's object-oriented features on their own terms. OOP is not one single way of programming; it is a continuum of ideas. In its object philosophy, Turbo Pascal 5.5 is more like C++ than Smalltalk. Smalltalk is an interpreter, while from the beginning, Turbo Pascal has been a pure native code compiler. Native code compilers do things differently (and far more quickly) than interpreters. Turbo Pascal was designed to be a production development tool, not a research tool.

*And a note to you who haven't any notion at all what OOP is about:* That's just as well. Too much hype, too much confusion, and too many people talking about something they don't understand have greatly muddied the waters in the last year or so. Strive to forget what people have told you about OOP. The best way (in fact, the *only* way) to learn anything useful about OOP is to do what you're about to do: Sit down and try it yourself.

## Objects?

---

Yes, objects. Look around you...there's one: the apple you brought in for lunch. Suppose you were going to describe an apple in software terms. The first thing you might be tempted to do is pull it apart: Let *S* represent the area of the skin; let *J* represent the fluid volume of juice it contains; let *F* represent the weight of fruit inside; let *D* represent the number of seeds....

Don't think that way. Think like a painter. You see an apple, and you paint an apple. The picture of an apple is not an apple; it's just a symbol on a flat surface. But it hasn't been abstracted into seven numbers, all standing alone and independent in a data segment somewhere. Its components remain together, in their essential relationships to one another.

Objects model the characteristics and behavior of the elements of the world we live in. They are the ultimate data abstraction so far.

An apple can be pulled apart, but once it's been pulled apart it's not an apple anymore. The relationships of the parts to the whole and to one another are plainer when everything is kept together

*Objects keep all their characteristics and behavior together.*

in one wrapper. This is called *encapsulation*, and it's very important. We'll return to encapsulation in a little while.

Of equal importance is the fact that objects can *inherit* characteristics and behavior from what are called *ancestor objects*. This is an intuitive leap; inheritance is perhaps the single biggest difference between object-oriented Pascal and Turbo Pascal programming today.

## Inheritance

---

The goal of science is to describe the workings of the universe. Much of the work of science, in furthering that goal, is simply the creation of family trees. When entomologists return from the Amazon with a previously unknown insect in a jar, their fundamental concern is working out where that insect fits into the giant chart upon which the scientific names of all other insects are gathered. There are similar charts of plants, fish, mammals, reptiles, chemical elements, subatomic particles, and external galaxies. They all look like family trees: a single overall category at the top, with an increasing number of categories beneath that single category, fanning out to the limits of diversity.

Within the category *insect*, for example, there are two divisions: insects with visible wings, and insects with hidden wings or no wings at all. Under winged insects is a larger number of categories: moths, butterflies, flies, and so on. Each category has numerous subcategories, and beneath those subcategories are even more subcategories (see Figure 1.1).

Figure 1.1  
A partial taxonomy chart of  
Insects

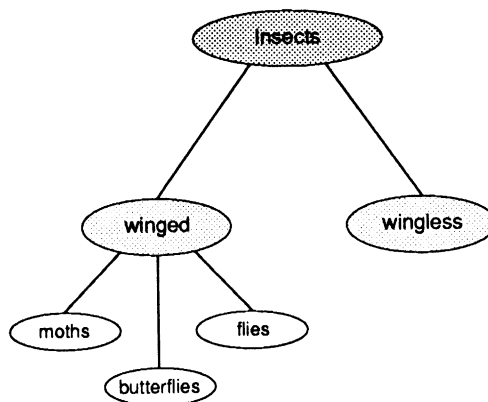

This classification process is called *taxonomy*. It's a good starting metaphor for the inheritance mechanism of object-oriented programming.

The questions that a scientist asks in trying to classify some new animal or object are these: *How is it similar to the others of its general class? How is it different?* Each different class has a set of behaviors and characteristics that define it. A scientist begins at the top of a specimen's family tree and starts descending the branches, asking those questions along the way. The highest levels are the most general, and the questions the simplest: Wings or no wings? Each level is more specific than the one before it, and less general. Eventually the scientist gets to the point of counting hairs on the third segment of the insect's hind legs—specific indeed. (And a good reason, perhaps, not to be an entomologist.)

The important point to remember is that once a characteristic is defined, all the categories *beneath* that definition *include* that characteristic. So once you identify an insect as a member of the order *diptera* (flies), you needn't make the point that a fly has one pair of wings. The species of insect called *flies* inherits that characteristic from its order.

As you'll learn shortly, object-oriented programming is the process of building family trees for data structures. One of the important things object-oriented programming adds to traditional languages like Pascal is a mechanism by which data types inherit characteristics from simpler, more general types. This mechanism is inheritance.

## Objects: Records that inherit

---

In Pascal terms, an object is very much like a record, which is a wrapper for joining several related elements of data together under one name. In a graphics environment, you might gather together the X and Y coordinates of a position on the graphics screen and call it a record type named *Location*:

```
Location = record
  X, Y : Integer;
end;
```

*Location* here is a *record type*; that is, it's a template that the compiler uses to create record variables. A variable of type *Location* is an instance of type *Location*. The term *instance* is used now and



then in Pascal circles, but it is used all the time by OOP people, and you'll do well to start thinking in terms of types and instances of those types.

With type *Location* you have it both ways: When you need to think of the X and Y coordinates separately, you can think of them separately as fields X and Y of the record. On the other hand, when you need to think of the X and Y coordinates working together to pin down a place on the screen, you can think of them collectively as *Location*.

Suppose you want to display a point of light at a position described on the screen by a *Location* record. In Pascal you might add a Boolean field indicating whether there is an illuminated pixel at a given location, and make it a new record type:

```
Point = record
  X, Y : Integer;
  Visible : Boolean;
end;
```

You might also be a little more clever and retain record type *Location* by creating a field of type *Location* within type *Point*:

```
Point = record
  Position : Location;
  Visible : Boolean;
end;
```

This works, and Pascal programmers do it all the time. One thing this method doesn't do is force you to think about the nature of what you're manipulating in your software. You need to ask questions like, "How does a point on the screen differ from a location on the screen?" The answer is this: A point is a location that lights up. Think back on the first part of that statement: A *point* is a *location*....

There you have it!

Implicit in the definition of a point is a location for that point. (Pixels exist only onscreen, after all.) Object-oriented programming recognizes that special relationship. Because all points must contain a location, type *Point* is a descendant type of type *Location*. *Point* inherits everything that *Location* has, and adds whatever is new about *Point* to make *Point* what it must be.

This process by which one type inherits the characteristics of another type is called *inheritance*. The inheritor is called a

*descendant type*; the type that the descendant type inherits from is an *ancestor type*.

The familiar Pascal record types cannot inherit. Turbo Pascal 5.5, however, extends the Pascal language to support inheritance. One of these extensions is a new category of data structure, related to records but far more powerful. Data types in this new category are defined with a new reserved word: **object**. An object type can be defined as a complete, stand-alone type in the fashion of Pascal records, or it can be defined as a descendant of an existing object type by placing the name of the ancestor type in parentheses after the reserved word **object**.

In the graphics example you just looked at, the two related object types would be defined this way:

```
type
  Location = object
    X, Y : Integer;
  end;

  Point = object(Location)
    Visible : Boolean;
  end;
```

Note the use of parentheses here to denote inheritance.

Here, *Location* is the ancestor type, and *Point* is the descendant type. As you'll see a little later, the process can continue indefinitely: You can define descendants of type *Point*, and descendants of *Point*'s descendant type, and so on. A large part of designing an object-oriented application lies in building this *object hierarchy* expressing the family tree of the objects in the application.

All the types eventually inheriting from *Location* are called *Location*'s descendant types, but *Point* is one of *Location*'s *immediate descendants*. Conversely, *Location* is *Point*'s *immediate ancestor*. An object type (just like a DOS subdirectory) can have any number of immediate descendants, but only one immediate ancestor.

Objects are closely related to records, as these definitions show. The new reserved word **object** is the most obvious difference, but there are numerous other differences, some of them quite subtle, as you'll see later.

For example, the *X* and *Y* fields of *Location* are not explicitly written into type *Point*, but *Point* has them anyway, by virtue of inheritance. You can speak about *Point*'s *X* value, just as you can speak about *Location*'s *X* value.

---

## Instances of object types

Instances of object types are declared just as any variables are declared in Pascal, either as static variables or as pointer referents allocated on the heap:

```
type
  PointPtr = ^Point;

var
  StatPoint : Point;      { Ready to go! }
  DynaPoint : PointPtr;  { Must allocate with New before use }
```

---

## An object's fields

You access an object's data fields just as you access the fields of an ordinary record, either through the **with** statement or by *dotting*. For example,

```
MyPoint.Visible := False;

with MyPoint do
begin
  X := 341;
  Y := 42;
end;
```

*Don't forget: An object's inherited fields are not treated specially simply because they are inherited.*

You just have to remember at first (eventually it comes naturally) that inherited fields are just as accessible as fields declared within a given object type. For example, even though X and Y are not part of *Point*'s declaration (they are inherited from type *Location*), you can specify them just as though they were declared within *Point*:

```
MyPoint.X := 17;
```

---

## Good practice and bad practice

Even though you can access an object's fields directly, it's not an especially good idea to do so. Object-oriented programming principles require that an object's fields be left alone as much as possible. This restriction might seem arbitrary and rigid at first, but it's part of the big picture of OOP that is being built in this chapter. In time you'll see the sense behind this new definition of good programming practice, though there's some ground to cover before it all comes together. For now, take it on faith: Avoid accessing object data fields directly.

So—how are object fields accessed? What sets them and reads them?

*An object's data fields are what an object knows; its methods are what an object does.*

The answer is that an object's *methods* are used to access an object's data fields whenever possible. A *method* is a procedure or function declared *within* an object and tightly bonded to that object.

## Methods

---

Methods are one of object-oriented programming's most striking attributes, and they take some getting used to. Start by harkening back to that fond old necessity of structured programming, initializing data structures. Consider the task of initializing a record with this definition:

```
Location = record
  X, Y : Integer;
end;
```

Most programmers would use a **with** statement to assign initial values to the X and Y fields:

```
var
  MyLocation : Location;

with MyLocation do
begin
  X := 17;
  Y := 42;
end;
```

This works well, but it's tightly bound to one specific record instance, *MyLocation*. If more than one *Location* record needs to be initialized, you'll need more **with** statements that do essentially the same thing. The natural next step is to build an initialization procedure that generalizes the **with** statement to encompass any instance of a *Location* type passed as a parameter:

```
procedure InitLocation(var Target : Location;
  NewX, NewY : Integer);
begin
  with Target do
  begin
    X := NewX;
    Y := NewY;
  end;
end;
```

This does the job, all right—but if you’re getting the feeling that it’s a little more fooling around than it ought to be, you’re feeling the same thing that object-oriented programming’s early proponents felt.

It’s a feeling that implies that, well, you’ve designed procedure *InitLocation* specifically to serve type *Location*. Why, then, must you keep specifying what record type and instance *InitLocation* acts upon? There should be some way of welding together the record type and the code that serves it into one seamless whole.

Now there is. It’s called a *method*. A method is a procedure or function welded so tightly to a given type that the method is surrounded by an invisible **with** statement, making instances of that type accessible from within the method. The type definition includes the header of the method. The full definition of the method is qualified with the name of the type. Object type and object method are the two faces of this new species of structure called an object:

```
type
  Location = object
    X, Y : Integer;
    procedure Init(NewX, NewY : Integer);
  end;

procedure Location.Init(NewX, NewY : Integer);
begin
  X := NewX; { The X field of a Location object }
  Y := NewY; { The Y field of a Location object }
end;
```

Now, to initialize an instance of type *Location*, you simply call its method as though the method were a field of a record, which in one very real sense it is:

```
var
  MyLocation : Location;

MyLocation.Init(17, 42); { Easy, no? }
```

---

## Code and data together

One of the most important tenets of object-oriented programming is that the programmer should think of code and data *together* during program design. Neither code nor data exists in a vacuum. Data directs the flow of code, and code manipulates the shape and values of data.

When your data and code are separate entities, there's always the danger of calling the right procedure with the wrong data or the wrong procedure with the right data. Matching the two is the programmer's job, and while Pascal's strong typing does help, at best it can only say what *doesn't* go together.

Pascal says nothing, anywhere, about what *does* go together. If it's not in a comment or in your head, you take your chances.

By bundling code and data declarations together, an object helps keep them in sync. Typically, to get the value of one of an object's fields, you call a method belonging to that object that returns the value of the desired field. To set the value of a field, you call a method that assigns a new value to that field.

Turbo Pascal 5.5 does not enforce this. Like structured programming, object-oriented programming is a discipline you must enforce upon yourself, using tools provided by the language. Turbo Pascal *allows* you to read and write an object's fields directly from outside the object—but it *encourages* you to follow good OOP practice and create methods to manipulate an object's fields from within the object.

## Defining methods

---

The process of defining an object's methods is reminiscent of Turbo Pascal units. Inside an object, a method is defined by the header of the function or procedure acting as a method:

```
type
  Location = object
    X, Y : Integer;
    procedure Init(InitX, InitY : Integer);
    function GetX : Integer;
    function GetY : Integer;
end;
```

*All data fields must be declared before the first method declaration.*

As with procedure and function declarations in a unit's **interface** section, method declarations within an object tell *what* a method does, but not *how*.

The *how* is defined *outside* the object definition, in a separate procedure or function declaration. When methods are fully defined outside the object, the method name must be preceded by the name of the object type that owns the method, followed by a period:

```

procedure Location.Init(InitX, InitY : Integer);
begin
  X := InitX;
  Y := InitY;
end;

function Location.GetX : Integer;
begin
  GetX := X;
end;

function Location.GetY : Integer;
begin
  GetY := Y;
end;

```

Method definition follows the intuitive dotting method of specifying a record field. In addition to having a definition of *Location.GetX*, it would be completely legal to define a procedure named *GetX* without the identifier *Location* preceding it. However, the “outside” *GetX* would have no connection to the object type *Location* and would probably confuse the sense of the program as well.

---

## Method scope and the Self parameter

Notice that nowhere in the previous methods is there an explicit **with** object **do...** construct. The data fields of an object are freely available to that object’s methods. Although they are separated in the source code, the method bodies and the object’s data fields really share the same scope.

This is why one of *Location*’s methods can contain the statement *GetY := Y* without any qualifier to *Y*. It’s because *Y belongs to the object that called the method*. When an object calls a method, there is an implicit statement to the effect **with myself do** method linking the object and its method in scope.

This implicit **with** statement is accomplished by the passing of an invisible parameter to the method each time any method is called. This parameter is called *Self*, and is actually a full 32-bit pointer to the object instance making the method call. The *GetY* method belonging to *Location* is roughly equivalent to the following:

*This example is not fully correct syntactically; it's here simply to give you a fuller appreciation for the special link between an object and its methods.*

```
function Location.GetY(var Self : Location) : Integer;  
begin  
    GetY := Self.Y;  
end;
```

Is it important for you to be aware of *Self*? Ordinarily, no. Turbo Pascal's generated code handles it all automatically in virtually all cases. There are a few circumstances, however, when you might have to intervene inside a method and make explicit use of the *Self* parameter.

*Explicit use of Self is legal, but you should avoid situations that require it.*

*Self* is actually an automatically declared identifier, and if you happen to find yourself in the midst of an identifier conflict within a method, you can resolve it by using the *Self* identifier as a qualifier to any data field belonging to the method's object:

```
type  
    MouseStat = record  
        Active : Boolean;  
        X, Y : Integer;  
        LButton, RButton : Boolean;  
        Visible : Boolean;  
    end;  
  
procedure Location.GoToMouse(MousePos : MouseStat);  
begin  
    Hide;  
    with MousePos do  
        begin  
            Self.X := X;  
            Self.Y := Y;  
        end;  
    Show;  
end;
```

*Methods implemented as externals in assembly language must take Self into account when they access method parameters on the stack. For more details on method call stack frames, see page 104.*

This example is necessarily simple, and the use of *Self* could be avoided simply by abandoning the use of the **with** statement inside *Location.GoToMouse*. You might find yourself in a situation inside a complex method where the use of **with** statements simplifies the logic enough to make *Self* worthwhile. The *Self* parameter is part of the physical stack frame for all method calls.



---

## Object data fields and method formal parameters

One consequence of the fact that methods and their objects share the same scope is that a method's formal parameters cannot be identical to any of the object's data fields. This is not some new restriction imposed by object-oriented programming, but rather the same old scoping rule that Pascal has always had. It's the same as not allowing the formal parameters of a procedure to be identical to the procedure's local variables:

```
procedure CrunchIt (Crunchee : MyDataRec,  
                   Crunchby, ErrorCode : Integer);  
  
var  
  A, B : Char;  
  ErrorCode : Integer; { This declaration causes an error! }  
begin  
  ...
```

A procedure's local variables and its formal parameters share the same scope and thus cannot be identical. You'll get "Error 4: Duplicate identifier" if you try to compile something like this; the same error occurs if you attempt to give a method a formal parameter identical to any field in the object that owns the method.

The circumstances are a little different, since having procedure headers inside a data structure is a wrinkle new to Turbo Pascal 5.5, but the guiding principles of Pascal scoping have not changed at all.

---

## Objects exported by units

It makes good sense to define objects in units, with the object type declaration in the interface section of the unit and the procedure bodies of the object type's methods defined in the implementation section.

*Exported means "defined within the interface section of a unit."*

Units can have their own private object type definitions in the implementation section, and such types are subject to the same restrictions as any types defined in a unit implementation section. An object type defined in the interface section of a unit can have descendant object types defined in the implementation section of the unit. In a case where unit *B* uses unit *A*, unit *B* can also define descendant types of any object type exported by unit *A*.

The object types and methods described earlier can be defined within a unit in this way:

```
unit Points;

interface

uses Graph;

type
  Location = object
    X, Y : Integer;
    procedure Init(InitX, InitY : Integer);
    function GetX : Integer;
    function GetY : Integer;
  end;

  Point = object(Location)
    Visible : Boolean;
    procedure Init(InitX, InitY : Integer);
    procedure Show;
    procedure Hide;
    function IsVisible : Boolean;
    procedure MoveTo(NewX, NewY : Integer);
  end;

implementation

{-----}
{ Location's method implementations:           }
{-----}

procedure Location.Init(InitX, InitY : Integer);
begin
  X := InitX;
  Y := InitY;
end;

function Location.GetX : Integer;
begin
  GetX := X;
end;

function Location.GetY : Integer;
begin
  GetY := Y;
end;
```

```

{-----}
{ Point's method implementations:           }
{-----}

procedure Point.Init(InitX, InitY : Integer);
begin
    Location.Init(InitX, InitY);
    Visible := False;
end;

procedure Point.Show;
begin
    Visible := True;
    PutPixel(X, Y, GetColor);
end;

procedure Point.Hide;
begin
    Visible := False;
    PutPixel(X, Y, GetBkColor);
end;

function Point.IsVisible : Boolean;
begin
    IsVisible := Visible;
end;

procedure Point.MoveTo(NewX, NewY : Integer);
begin
    Hide;
    X := NewX;
    Y := NewY;
    Show;
end;

end.

```

To make use of the object types and methods defined in unit *Points*, you simply use the unit in your own program, and declare an instance of type *Point* in the **var** section of your program:

```

program MakePoints;

uses Graph, Points;

var
    APoint : Point;
    ...

```

To create and show the point represented by *APoint*, you simply call *APoint's* methods, using the dot syntax:

```

APoint.Init(151, 82);      { Initial X,Y at 151,82 }
APoint.Show;              { APoint turns itself on }
APoint.MoveTo(163, 101); { APoint moves to 163,101 }
APoint.Hide;              { APoint turns itself off }

```

*Objects can also be typed constants; see page 82.*

Objects, being very similar to records, can also be used inside **with** statements. In that case, naming the object that owns the method isn't necessary:

```

with APoint do
begin
  Init(151, 82);      { Initial X,Y at 151,82 }
  Show;              { APoint turns itself on }
  MoveTo(163, 101); { APoint moves to 163,101 }
  Hide;              { APoint turns itself off }
end;

```

Just as with records, objects can be passed to procedures as parameters and (as you'll see later on) can also be allocated on the heap.

## Programming in the active voice

---

Most of what's been said about objects so far has been from a comfortable, Turbo Pascal-ish perspective, since that's most likely where you are coming from. This is about to change, as you move on to OOP concepts with fewer precedents in standard Pascal programming. Object-oriented programming has its own particular mindset, due in part to OOP's origins in the (somewhat insular) research community, but also because the concept is truly and radically different.

*Object-oriented languages were once called "actor languages" with this metaphor in mind.*

One often amusing outgrowth of this is that OOP fanatics anthropomorphize their objects. Data structures are no longer passive buckets that you toss values into. In the new view of things, an object is looked upon as an actor on a stage, with a set of lines (methods) memorized. When you (the director) give the word, the actor recites from the script.

It can be helpful to think of the statement `APoint.MoveTo(242,118)` as giving an order to object `APoint`, saying "Move yourself to location 242,118." The object is the central concept here. Both the list of methods and the list of data fields contained by the object serve the object. Neither code nor data is boss.

Objects aren't being described as actors on a stage just to be cute. The object-oriented programming paradigm tries very hard to

model the components of a problem as components, and not as logical abstractions. The odds and ends that fill our lives, from toasters to telephones to terry towels, all have characteristics (data) and behaviors (methods). A toaster's characteristics might include the voltage it requires, the number of slices it can toast at once, the setting of the light/dark lever, its color, its brand, and so on. Its behaviors include accepting slices of bread, toasting slices of bread, and popping toasted slices back up again.

If you wanted to write a kitchen simulation program, what better way to do it than to model the various appliances as objects, with their characteristics and behaviors encoded into data fields and methods? It's been done, in fact; the very first object-oriented language (Simula-67) was created as a language for writing such simulations.

This is the reason that object-oriented programming is so firmly linked in conventional wisdom to graphics-oriented environments. Objects should be simulations, and what better way to simulate an object than to draw a picture of it? Objects in Turbo Pascal 5.5 should model components of the problem you're trying to solve. Keep that in mind as you further explore Turbo Pascal's new object-oriented extensions.

## Encapsulation

---

The welding of code and data together into objects is called *encapsulation*. If you're thorough, you can provide enough methods so that a user of the object never has to access its fields directly. Some other object-oriented languages like Smalltalk enforce encapsulation, but in Turbo Pascal 5.5 you have the choice, and good object-oriented programming practice is very much your responsibility.

*Location* and *Point* are written such that it is completely unnecessary to access any of their internal data fields directly:

```
type
  Location = object
    X, Y : Integer;
    procedure Init(InitX, InitY : Integer);
    function GetX : Integer;
    function GetY : Integer;
end;
```

```

Point = object(Location)
  Visible : Boolean;
  procedure Init(InitX, InitY : Integer);
  procedure Show;
  procedure Hide;
  function IsVisible : Boolean;
  procedure MoveTo(NewX, NewY : Integer);
end;

```

There are only three data fields here: *X*, *Y*, and *Visible*. The *MoveTo* method loads new values into *X* and *Y*, and the *GetX* and *GetY* methods return the values of *X* and *Y*. This leaves no further need to access *X* or *Y* directly. *Show* and *Hide* toggle the Boolean *Visible* between True and False, and the *IsVisible* function returns *Visible*'s current state.

Assuming an instance of type *Point* called *APoint*, you would use this suite of methods to manipulate *APoint*'s data fields indirectly, like this:

```

with APoint do
begin
  Init(0, 0);           { Init new point at 0,0 }
  Show;                { Make the point visible }
end;

```

Note that the object's fields are not accessed at all except by the object's methods.

---

## Methods: No downside

Adding these methods bulks up *Point* a little in source form, but the Turbo Pascal smart linker strips out any method code that is never called in a program. You therefore shouldn't hang back from giving an object type a method that might or might not be used in every program that uses the object type. Unused methods cost you nothing in performance or .EXE file size—if they're not used, they're simply not there.

*A note about data  
abstraction* ||||▶

There are powerful advantages to being able to completely decouple *Point* from global references. If nothing outside the object "knows" the representation of its internal data, the programmer who controls the object can alter the details of the internal data representation—as long as the method headers remain the same.

Within some object, data might be represented as an array, but later on (perhaps as the scope of the application grows and its

data volume expands), a binary tree might be recognized as a more efficient representation. If the object is completely encapsulated, a change in data representation from an array to a binary tree *does not alter the object's use at all*. The interface to the object remains completely the same, allowing the programmer to fine-tune an object's performance without breaking any code that uses the object.

---

## Extending objects

People who first encounter Pascal often take for granted the flexibility of the standard procedure *WriteLn*, which allows a single procedure to handle parameters of many different types:

```
WriteLn(CharVar);      { Outputs a character value }
WriteLn(IntegerVar);   { Outputs an integer value }
WriteLn(RealVar);     { Outputs a floating-point value }
```

Unfortunately, standard Pascal has no provision for letting you create equally flexible procedures of your own.

Object-oriented programming solves this problem through inheritance: When a descendant type is defined, the methods of the ancestor type are inherited, but they can also be overridden if desired. To override an inherited method, simply define a new method with the same name as the inherited method, but with a different body and (if necessary) a different set of parameters.

A simple example should make both the process and the implications clear. Let's define a descendant type to *Point* that draws a circle instead of a point on the screen:

```
type
Circle = object(Point)
  Radius : Integer;
  procedure Init(InitX, InitY : Integer;
                InitRadius : Integer);
  procedure Show;
  procedure Hide;
  procedure Expand(ExpandBy : Integer);
  procedure MoveTo(NewX, NewY : Integer);
  procedure Contract(ContractBy : Integer);
end;
```

```

procedure Circle.Init(InitX, InitY : Integer;
                      InitRadius : Integer);
begin
    Point.Init(InitX, InitY);
    Radius := InitRadius;
end;

procedure Circle.Show;
begin
    Visible := True;
    Graph.Circle(X, Y, Radius);
end;

procedure Circle.Hide;
var
    TempColor : Word;
begin
    TempColor := Graph.GetColor;
    Graph.SetColor(GetBkColor);
    Visible := False;
    Graph.Circle(X, Y, Radius);
    Graph.SetColor(TempColor);
end;

procedure Circle.Expand(ExpandBy : Integer);
begin
    Hide;
    Radius := Radius + ExpandBy;
    if Radius < 0 then Radius := 0;
    Show;
end;

procedure Circle.Contract(ContractBy : Integer);
begin
    Expand(-ContractBy);
end;

procedure Circle.MoveTo(NewX, NewY : Integer);
begin
    Hide;
    X := NewX;
    Y := NewY;
    Show;
end;

```

A circle, in a sense, is a fat point: It has everything a point has (an *X,Y* location, a visible/invisible state) plus a radius. Object type *Circle* appears to have only the single field *Radius*, but don't forget about all the fields that *Circle* inherits by being a descendant type of *Point*. *Circle* has *X*, *Y*, and *Visible* as well, even if you don't see them in the type definition for *Circle*.



Since *Circle* defines a new field, *Radius*, initializing it requires a new *Init* method that initializes *Radius* as well as the inherited fields. Rather than directly assigning values to inherited fields like *X*, *Y* and *Visible*, why not reuse *Point*'s initialization method (illustrated by *Circle.Init*'s first statement). The syntax for calling an inherited method is *Ancestor.Method*, where *Ancestor* is the type identifier of an ancestral object type, and *Method* is a method identifier of that type.

Note that calling the method you override is not merely good style; it's entirely possible that *Point.Init* (or *Location.Init* for that matter) performs some important, hidden initialization. By calling the overridden method, you ensure that the descendant object type includes its ancestor's functionality. In addition, any changes made to the ancestor's method automatically affects all its descendants.

After calling *Point.Init*, *Circle.Init* can then perform its own initialization, which in this case consists only of assigning *Radius* the value passed in *InitRadius*.

Instead of drawing and hiding your circle point by point, you can make use of the BGI *Circle* procedure. If you do, *Circle* also needs new *Show* and *Hide* methods that override those of *Point*. These rewritten *Show* and *Hide* methods appear in the example on page 25.

Dotting resolves the potential problems stemming from the name of the object type being the same as that of the BGI routine that draws the object type on the screen. *Graph.Circle* is also a completely unambiguous way of telling Turbo Pascal that you're referencing the *Circle* routine in GRAPH.TPU and not the *Circle* object type.

Important! IIII➡

Whereas methods can be overridden, data fields cannot. Once you define a data field in an object hierarchy, no descendant type can define a data field with precisely the same identifier.

---

## Inheriting static methods

One additional *Point* method is overridden in the earlier definition of *Circle*: *MoveTo*. If you're sharp, you might be looking at *MoveTo* and wondering why *MoveTo* doesn't use the *Radius* field, and why it doesn't make any BGI or other library calls specific to drawing circles. After all, the *GetX* and *GetY* methods are inherited all the way from *Location* without modification.

*Circle.MoveTo* is also completely identical to *Point.MoveTo*. Nothing was changed other than to copy the routine and give it *Circle's* qualifier in front of the *MoveTo* identifier.

This example demonstrates a problem with objects and methods set up in this fashion. All the methods shown so far in connection with the *Location*, *Point*, and *Circle* object types are static methods.

|||▶ The term *static* was chosen to describe methods that are not *virtual*. (You will learn about virtual methods shortly.) Virtual methods are in fact the solution to this problem, but in order to understand the solution you must first understand the problem.

The symptoms of the problem are these: Unless a copy of the *MoveTo* method is placed in *Circle's* scope to override *Point's MoveTo*, the method does not work correctly when it is called from an object of type *Circle*. If *Circle* invokes *Point's MoveTo* method, what is moved on the screen is a point rather than a circle. Only when *Circle* calls a copy of the *MoveTo* method defined in its own scope are circles hidden and drawn by the nested calls to *Show* and *Hide*.

Why so? It has to do with the way the compiler resolves method calls. When the compiler compiles *Point's* methods, it first encounters *Point.Show* and *Point.Hide* and compiles code for both into the code segment. A little later down the file it encounters *Point.MoveTo*, which calls both *Point.Show* and *Point.Hide*. As with any procedure call, the compiler replaces the source code references to *Point.Show* and *Point.Hide* with the addresses of their generated code in the code segment. Thus, when the code for *Point.MoveTo* is called, it in turn calls the code for *Point.Show* and *Point.Hide* and everything's in phase.

So far, this scenario is all classic Turbo Pascal and would have been true (except for the nomenclature) since version 1.0. Things change, however, when you get into inheritance. When *Circle* inherits a method from *Point*, *Circle* uses the method exactly as it was compiled.

Look again at what *Circle* would inherit if it inherited *Point.MoveTo*:

```

procedure Point.MoveTo(NewX, NewY : Integer);
begin
  Hide;      { Calls Point.Hide }
  X := NewX;
  Y := NewY;
  Show;     { Calls Point.Show }
end;

```

The comments were added to drive home the fact that when *Circle* calls *Point.MoveTo*, it also calls *Point.Show* and *Point.Hide*, not *Circle.Show* and *Circle.Hide*. *Point.Show* draws a point, not a circle. As long as *Point.MoveTo* calls *Point.Show* and *Point.Hide*, *Point.MoveTo* can't be inherited. Instead, it must be overridden by a second copy of itself that calls the copies of *Show* and *Hide* defined within its scope; that is, *Circle.Show* and *Circle.Hide*.

The compiler's logic in resolving method calls works like this: When a method is called, the compiler first looks for a method of that name defined within the object type. The *Circle* type defines methods named *Init*, *Show*, *Hide*, *Expand*, *Contract*, and *MoveTo*. If a *Circle* method were to call one of those five methods, the compiler would replace the call with the address of one of *Circle's* own methods.

If no method by a name is defined within an object type, the compiler goes up to the immediate ancestor type, and looks within that type for a method of the name called. If a method by that name is found, the address of the ancestor's method replaces the name in the descendant's method's source code. If no method by that name is found, the compiler continues up to the next ancestor, looking for the named method. If the compiler hits the very first (top) object type, it issues an error message indicating that no such method is defined.

But when a static inherited method is found and used, you must remember that the method called is the method exactly as it was defined *and compiled* for the ancestor type. If the ancestor's method calls other methods, the methods called are the ancestor's methods, even if the descendant has methods that override the ancestor's methods.

---

## Virtual methods and polymorphism

The methods discussed so far are static methods. They are static for the same reason that static variables are static: The compiler allocates them and resolves all references to them *at compile time*.

As you've seen, objects and static methods can be powerful tools for organizing a program's complexity.

Sometimes, however, they are not the best way to handle methods.

Problems like the one described in the previous section are due to the compile-time resolution of method references. The way out is to be dynamic—and resolve such references at run time. Certain special mechanisms must be in place for this to be possible, but Turbo Pascal provides those mechanisms in its support of virtual methods.

*Important!* ■■■▶

Virtual methods implement an extremely powerful tool for generalization called polymorphism. *Polymorphism* is Greek for “many shapes,” and it is just that: A way of giving an action one name that is shared up and down an object hierarchy, with each object in the hierarchy implementing the action in a way appropriate to itself.

The simple hierarchy of graphic figures already described provides a good example of polymorphism in action, implemented through virtual methods.

Each object type in our hierarchy represents a different type of figure onscreen: a point or a circle. It certainly makes sense to say that you can show a point on the screen, or show a circle. Later on, if you were to define objects to represent other figures such as lines, squares, arcs, and so on, you could write a method for each that would display that object onscreen. In the new way of object-oriented thinking, you could say that all these graphic figure types had the ability to show themselves on the screen. That much they all have in common.

What is different for each object type is the *way* it must show itself to the screen. A point is drawn with a point-plotting routine that needs nothing more than an *X,Y* location and perhaps a color value. A circle needs an entirely separate graphics routine to display itself, taking into account not only *X* and *Y*, but a radius as well. Still further, an arc needs a start angle and an end angle, and a more complex drawing algorithm to take them into account.

Any graphic figure can be shown, but the mechanism by which each is shown is specific to each figure. One word, “Show,” is used to show (literally) many shapes.

That's a good example of what polymorphism is, and virtual methods are how it is done in Turbo Pascal 5.5.

---

## Early binding vs. late binding

The difference between a static method call and a virtual method call is the difference between a decision made now and a decision delayed. When you code a static method call, you are in essence telling the compiler, "You know what I want. Go call it." Making a virtual method call, on the other hand, is like telling the compiler, "You don't know what I want—yet. When the time comes, ask the instance."

Think of this metaphor in terms of the *MoveTo* problem mentioned in the previous section. A call to *Circle.MoveTo* can only go to one place: the closest implementation of *MoveTo* up the object hierarchy. In that case, *Circle.MoveTo* would still call *Point's* definition of *MoveTo*, since *Point* is the closest up the hierarchy from *Circle*. Assuming that no descendent type defined its own *MoveTo* to override *Point's* *MoveTo*, any descendent type of *Point* would still call the same implementation of *MoveTo*. The decision can be made at compile time and that's all that needs to be done.

When *MoveTo* calls *Show*, however, it's a different story. Every figure type has its own implementation of *Show*, so which implementation of *Show* is called by *MoveTo* should depend entirely on what object instance originally called *MoveTo*. This is why the call to the *Show* method within the implementation of *MoveTo* must be a delayed decision: When the code for *MoveTo* is compiled, no decision as to which *Show* to call can be made. The information isn't available at compile time, so the decision has to be deferred until run time, when the object instance calling *MoveTo* can be queried.

The process by which static method calls are resolved unambiguously to a single method by the compiler at compile time is *early binding*. In early binding, the caller and the callee are connected (bound) at the earliest opportunity, that is, at compile time. With *late binding*, the caller and the callee cannot be bound at compile time, so a mechanism is put into place to bind the two later on, when the call is actually made.

The nature of the mechanism is interesting and subtle, and you'll see how it works a little later.

## Object type compatibility

Inheritance somewhat changes Turbo Pascal's type compatibility rules. In addition to everything else, a descendant type inherits type compatibility with all its ancestor types. This extended type compatibility takes three forms:

- between object instances
- between pointers to object instances
- between formal and actual parameters

In all three forms, however, it is critical to remember that type compatibility extends *only* from descendant to ancestor. In other words, descendant types can be freely used in place of ancestor types, but not vice versa.

Consider these declarations:

```
type
  LocationPtr = ^Location;
  PointPtr = ^Point;
  CirclePtr = ^Circle;

var
  ALocation : Location;
  APoint : Point;
  ACircle : Circle;
  PLocation : LocationPtr;
  PPoint : PointPtr;
  PCircle : CirclePtr;
```

With these declarations, the following assignments are legal:

*An ancestor object can be assigned an instance of any of its descendant types.*

```
ALocation := APoint;
APoint := ACircle;
ALocation := ACircle;
```

The reverse assignments are not legal.

This is a concept new to Pascal, and it might be a little hard to remember, at first, which way the type compatibility goes. Think of it this way: *The source must be able to completely fill the destination.* Descendant types contain everything their ancestor types contain by virtue of inheritance. Therefore a descendant type is either exactly the same size or (usually) larger than its ancestors, but never smaller. Assigning an ancestor object to a descendant object

could leave some of the descendant's fields undefined after the assignment, which is dangerous and therefore illegal.

In an assignment statement, only the fields that the two types have in common are copied from the source to the destination. In the assignment statement

```
ALocation := ACircle;
```

only the *X* and *Y* fields of *ACircle* are copied to *ALocation*, since *X* and *Y* are all that types *Circle* and *Location* have in common.

Type compatibility also operates between pointers to object types, under the same rule as for instances of object types: Pointers to descendants can be assigned to pointers to ancestors. These pointer assignments are also legal:

```
PPoint := PCircle;  
PLocation := PPoint;  
PLocation := PCircle;
```

Remember, the reverse assignments are not legal.

A formal parameter (either value or **var**) of a given object type can take as an actual parameter an object of its own, or any descendant type. Given this procedure header,

```
procedure DragIt(Target : Point);
```

actual parameters could legally be of type *Point* or *Circle*, but not type *Location*. *Target* could also be a **var** parameter; the same type compatibility rule applies.

**Warning!** 

However, keep in mind that there's a drastic difference between a value parameter and a **var** parameter: A **var** parameter is a pointer to the actual object passed as a parameter, whereas a value parameter is only a *copy* of the actual parameter. That copy, moreover, only includes the fields and methods included in the formal value parameter's type. This means the actual parameter is literally translated to the type of the formal parameter. A **var** parameter is more similar to a typecast, in that the actual parameter remains unaltered.

Similarly, if a formal parameter is a pointer to an object type, the actual parameter can be a pointer to that object type or a pointer to any of that object's descendant types. Given this procedure header,

```
procedure Figure.Add(NewFigure : PointPtr);
```

actual parameters could legally be of type *PointPtr* or *CirclePtr*, but not type *LocationPtr*.

## Polymorphic objects

---

In reading the previous section, you might have asked yourself: If any descendant type of a parameter's type can be passed in the parameter, how does the user of the parameter know which object type it is receiving? In fact, the user does not know, not directly. The exact type of the actual parameter is unknown at compile time. It could be any one of the object types descended from the **var** parameter type and is thus called a *polymorphic object*.

Now, exactly what are polymorphic objects good for? Primarily, this: *Polymorphic objects allow the processing of objects whose type is not known at compile time.* This whole notion is so new to the Pascal way of thinking that an example might not occur to you immediately. (You'll be surprised, in time, at how natural it begins to seem. That's when you'll truly be an object-oriented programmer.)

Suppose you've written a graphics drawing toolbox that supports numerous types of figures: points, circles, squares, rectangles, curves, and so on. As part of the toolbox, you want to write a routine that drags a graphics figure around the screen with the mouse pointer.

The old way would have been to write a separate drag procedure for each type of graphics figure supported by the toolbox. You would have had to write *DragCircle*, *DragSquare*, *DragRectangle*, and so on. Even if the strong typing of Pascal allowed it (and don't forget, there are always ways to circumvent strong typing), the differences between the types of graphics figures would seem to prevent a truly general dragging routine from being written.

After all, a circle has a radius but no sides, a square has one length of side, a rectangle two different lengths of side, and curves, arrgh....

At this point, clever Turbo Pascal hackers will step forth and say, do it this way: Pass the graphics figure record to procedure *DragIt* as the referent of a generic pointer. Inside *DragIt*, examine a tag field at a fixed offset inside the graphics figure record to determine what sort of figure it is, and then branch using a **case** statement:



```

case FigureIDTag of
  Point    : DragPoint;
  Circle   : DragCircle;
  Square   : DragSquare;
  Rectangle : DragRectangle;
  Curve    : DragCurve;
  ...

```

Well, placing seventeen small suitcases inside one enormous suitcase is a slight step forward, but what's the real problem with this way of doing things?

What if the user of the toolbox defines some new graphics figure type?

What indeed? What if the user designs traffic signs and wants to work with octagons for stop signs? The toolbox does not have an Octagon type, so *DragIt* would not have an Octagon label in its **case** statement, and would therefore refuse to drag the new Octagon figure. If it were presented to *DragIt*, Octagon would fall out in the **case** statement's **else** clause as an "unrecognized figure."

Plainly, building a toolbox of routines for sale without source code suffers from this problem: The toolbox can only work on data types that it "knows," that is, that are defined by the designers of the toolbox. The user of the toolbox is powerless to extend the function of the toolbox in directions unanticipated by the toolbox designers. What the user buys is what the user gets. Period.

The way out is to use Turbo Pascal's extended type compatibility rules for objects and design your application to use polymorphic objects and virtual methods. If a toolbox *DragIt* procedure is set up to work with polymorphic objects, it works with any objects defined within the toolbox—and any descendant objects that you define yourself. If the toolbox object types use virtual methods, the toolbox objects and routines can work with your custom graphics figures *on the figures' own terms*. A virtual method you define today is callable by a toolbox .TPU unit file that was written and compiled a year ago. Object-oriented programming makes it possible, and virtual methods are the key.

Understanding how virtual methods make such polymorphic method calls possible requires a little background on how virtual methods are declared and used.

## Virtual methods

---

A method is made virtual by following its declaration in the object type with the new reserved word **virtual**. Remember that if you declare a method in an ancestor type **virtual**, all methods of the same name in any descendant must also be declared **virtual** to avoid a compiler error.

Here are the graphics shape objects you've been seeing, properly virtualized:

```
type
  Location = object
    X, Y : Integer;
    procedure Init(InitX, InitY : Integer);
    function GetX : Integer;
    function GetY : Integer;
  end;

  Point = object(Location)
    Visible : Boolean;
    constructor Init(InitX, InitY : Integer);
    procedure Show; virtual;
    procedure Hide; virtual;
    function IsVisible : Boolean;
    procedure MoveTo(NewX, NewY : Integer);
  end;

  Circle = object(Point)
    Radius : Integer;
    constructor Init(InitX, InitY : Integer;
                    InitRadius : Integer);
    procedure Show; virtual;
    procedure Hide; virtual;
    procedure Expand(ExpandBy : Integer); virtual;
    procedure Contract(ContractBy : Integer); virtual;
  end;
```

Notice first of all that the *MoveTo* method shown in the last iteration of type *Circle* is gone from *Circle*'s type definition. *Circle* no longer needs to override *Point*'s *MoveTo* method with an unmodified copy compiled within its own scope. Instead, *MoveTo* can now be inherited from *Point*, with all *MoveTo*'s nested method calls going to *Circle*'s methods rather than *Point*'s, as happens in an all-static object hierarchy.

We suggest the use of the identifier *Init* for object constructors.

Also, notice the new reserved word **constructor** replacing the reserved word **procedure** for *Point.Init* and *Circle.Init*. A constructor is a special type of procedure that does some of the setup work for the machinery of virtual methods.

Warning! !!!!!➔

*Every object type that has virtual methods must have a constructor.*

Warning! !!!!!➔

The constructor must be called before any virtual method is called. Calling a virtual method without previously calling the constructor can cause system lockup, and the compiler has no way to check the order in which methods are called.

Warning! !!!!!➔

Each individual instance of an object must be initialized by a separate constructor call. It is not sufficient to initialize one instance of an object and then assign that instance to additional instances. The additional instances, while they might contain correct data, are not initialized by the assignment statements, and lock up the system if their virtual methods are called.

What do constructors construct? Every object type has something called a *virtual method table* (VMT) in the data segment. The VMT contains the object type's size and, for each of its virtual methods, a pointer to the code implementing that method. What the constructor does is establish a link between the instance calling the constructor and the object type's VMT.

That's important to remember: There is only one virtual method table for each object type. Individual instances of an object type (that is, variables of that type) contain a link to the VMT—they do not contain the VMT itself. The constructor sets the value of that link to the VMT—which is why you can launch execution into nowhere by calling a virtual method before calling the constructor.

Range checking virtual method calls

The default state of *\$R* is inactive, *{\$R-}*.

During program development, you might wish to take advantage of a safety net that Turbo Pascal 5.5 places beneath virtual method calls. If the *\$R* toggle is in its active state, *{\$R+}*, all virtual method calls are checked for the initialization status of the instance making the call. If the instance making the call has not been initialized by its constructor, a range check run-time error occurs.

Once you've shaken out a program and are certain that no method calls from uninitialized instances are present, you can speed your code up somewhat by setting the *\$R* toggle to its inactive state, *{\$R-}*. Method calls from uninitialized instances will no longer be

checked for, and will probably lock up your system if they're found.

Once virtual, always virtual

Notice that both *Point* and *Circle* have methods named *Show* and *Hide*. All method headers for *Show* and *Hide* are tagged as virtual methods with the reserved word **virtual**. Once an ancestor object type tags a method as **virtual**, all its descendant types that implement a method of that name must tag that method **virtual** as well. In other words, a static method can never override a virtual method. If you try, a compiler error results.

You should also keep in mind that the method heading cannot change in *any* way downward in an object hierarchy once the method is made virtual. You might think of each definition of a virtual method as a gateway to *all* of them. For this reason, the headers for all implementations of the same virtual method must be identical, right down to the number and type of parameters. This is not the case for static methods; a static method overriding another can have different numbers and types of parameters as necessary.

An example of late binding

---

To show how to use polymorphic objects with late binding in a Turbo Pascal 5.5 program, let's return to the graphics figures unit described on page 20. The goal is to create a unit that exports several graphics figure objects (like *Point* and *Circle*) and a generalized means of dragging any of them around the screen. The unit, named *Figures*, is a simple implementation of the graphics toolbox discussed earlier. To demonstrate *Figures*, let's build a simple program that defines a new figure object type unknown to *Figures* and then uses virtual methods to drag that new figure type around the screen.

Think about how graphics figures are alike and how they differ. The differences are obvious, and all involve shapes and angles and curves drawn onscreen. In the simple graphics program we'll describe, figures displayed onscreen share these attributes:

- They have a location, given as *X,Y*. The point within a figure considered to lie at this *X,Y* position is called the figure's *anchor point*.
- They can be either visible or invisible, specified by a Boolean value of True (visible) or False (invisible).

If you recall the earlier examples, these are precisely the characteristics of the *Location* and *Point* object types. *Point*, in fact, represents a sort of “grandparent” type from which all graphics figure objects are descended.

The rationale demonstrates an important principle of object-oriented programming: In defining a hierarchy of object types, gather all common attributes into a single type and allow the hierarchy of types to inherit all common elements from that type.

A note about abstract objects



Type *Point* acts as a template from which its descendant object types can take elements common to all types in the hierarchy. In this example, no object of type *Point* is ever actually drawn to the screen, though no harm would come of doing so. (Calling *Point.Show* would obviously display a point on the screen.) An object type specifically designed to provide inheritable characteristics for its descendants is called an *abstract* object type. The point of an abstract type is to have descendants, not instances.

Go back to page 36 and read *Point* over once more, this time as a compendium of all the things that graphics figures have in common. *Point* inherits *X* and *Y* from the even earlier *Location* type, but *Point* contains *X* and *Y* nonetheless, and can bequeath them to its descendant types. Note that none of *Point*'s methods address the shape of a figure, but all figures can be visible or invisible and can be moved around on the screen.

*Point* also has an important function as a “broadcasting station” for changes to the object hierarchy *as a whole*. If some new feature is devised that applies to all graphics figures (color support, for example), it can be added to all object types descended from *Point* simply by adding the new features to *Point*. The new features are instantly callable from any of *Point*'s descendant types. A method for moving a figure to the current position of the mouse pointer, for example, could be added to *Point* without changing any figure-specific methods, since such a method would only affect the two fields *X* and *Y*.

Obviously, if the new feature must be implemented differently for different figures, there must be a whole family of figure-specific virtual methods added to the hierarchy, each method overriding the one belonging to its immediate ancestor. Color, for example, would require minor changes to *Show* and *Hide* up and down the line, since the syntax of many GRAPH.TPU drawing routines depends on how drawing color is specified.

## Procedure or method?

A major goal in designing the FIGURES.PAS unit is to allow users of the unit to extend the object types defined in the unit—and still make use of all the unit's features. It is an interesting challenge to create some means of dragging an arbitrary graphics figure around the screen in response to user input.

There are two ways to go about it. The way that might first occur to traditional Pascal programmers is to have FIGURES.PAS export a procedure that takes a polymorphic object as a `var` parameter, and then drags that object around the screen. Such a procedure is shown here:

```
procedure DragIt(var AnyFigure : Point; DragBy : Integer);  
var  
    DeltaX,DeltaY : Integer;  
    FigureX,FigureY : Integer;  
  
begin  
    AnyFigure.Show;           { Display figure to be dragged }  
    FigureX := AnyFigure.GetX; { Get the initial X,Y of figure }  
    FigureY := AnyFigure.GetY;  
  
    { This is the drag loop }  
    while GetDelta(DeltaX, DeltaY) do  
    begin           { Apply delta to figure X,Y: }  
        FigureX := FigureX + (DeltaX * DragBy);  
        FigureY := FigureY + (DeltaY * DragBy);  
        { And tell the figure to move }  
        AnyFigure.MoveTo(FigureX, FigureY);  
    end;  
end;
```

*This procedure works fine, but the OOP way of doing it is more elegant (see page 43).*

*DragIt* calls an additional procedure, *GetDelta*, that obtains some sort of change in *X* and *Y* from the user. It could be from the keyboard, or from a mouse, or a joystick. (For simplicity's sake, our example obtains input from the arrow keys on the keypad.)

What's important to notice about *DragIt* is that any object of type *Point* or any type descended from *Point* can be passed in the *AnyFigure* `var` parameter. Instances of *Point* or *Circle*, or any type defined in the future that inherits from *Point* or *Circle*, can be passed without complication in *AnyFigure*.

How does *DragIt*'s code know what object type is actually being passed? It doesn't—and that's OK. *DragIt* only references identifiers defined in type *Point*. By inheritance, those identifiers

are also defined in any descendant of type *Point*. The methods *GetX*, *GetY*, *Show*, and *MoveTo* are just as truly present in type *Circle* as in type *Point*, and would be present in any future type defined as a descendant of either.

*GetX*, *GetY*, and *MoveTo* are static methods, which means that *DragIt* knows the procedure address of each at compile time. *Show*, on the other hand, is a virtual method. There is a different implementation of *Show* for both *Point* and *Circle*—and *DragIt* does not know at compile time which implementation is to be called. In brief, when *DragIt* is called, *DragIt* looks up the address of the correct implementation of *Show* in the VMT of the instance passed in *AnyFigure*. If the instance is a *Circle*, *DragIt* calls *Circle.Show*. If the instance is a *Point*, *DragIt* calls *Point.Show*. The decision as to which implementation of *Show* is called is not made until run time, and not, in fact, until the moment in the program when *DragIt* must call virtual method *Show*.

Now, *DragIt* works quite well, and if it is exported by the toolbox unit, it can drag any descendant type of *Point* around the screen, whether that type existed when the toolbox was compiled or not. But you have to think a little further: If any object can be dragged around the screen, why not make dragging a feature of the graphics objects themselves?

In other words, why not make *DragIt* a method?

Make it a method!

Indeed. Why pass an object to a procedure to drag the object around the screen? That's old-school thinking. If a procedure can be written to drag any graphics figure object around the screen, then the graphics figure objects ought to be able to drag themselves around the screen.

In other words, procedure *DragIt* really ought to be method *Drag*.

Adding a new method to an existing object hierarchy involves a little thought. How far up the hierarchy should the method be placed? Think about the utility provided by the method and decide how broadly applicable that utility is. Dragging a figure involves changing the location of the figure in response to input from the user. Metaphorically, you might think of a *Drag* method as *MoveTo* with an internal power source. In terms of inheritability, it sits right beside *MoveTo*—any object to which *MoveTo* is appropriate should also inherit *Drag*. *Drag* should thus be added

to our abstract object type, *Point*, so that all *Point*'s descendants can share it.

Does *Drag* need to be **virtual**? The litmus test for making any method virtual is whether the functionality of the method is expected to change somewhere down the hierarchy tree. *Drag* is a closed-ended sort of feature. It only manipulates the *X,Y* position of a figure, and one doesn't imagine that it would become more than that. Therefore, it probably doesn't need to be virtual.

Still, you should use caution in any such decision: If you don't make *Drag* virtual, you lock out all opportunities for users of FIGURES.PAS to alter it in their efforts to extend FIGURES.PAS. You might not be able to imagine the circumstances under which a user might want to rewrite *Drag*. That doesn't for a moment mean that such circumstances will not arise.

For example, *Drag* has a joker in it that tips the balance in favor of its being virtual: It deals with *event handling*, that is, the interception of input from devices like the keyboard and mouse, which occur at unpredictable times yet must be handled when they occur. Event handling is a messy business, and often very hardware-specific. If your user has some input device that does not meld well with *Drag* as you present it, the user will be helpless to rewrite *Drag*. Don't burn any bridges. Make *Drag* virtual.

The process of converting *DragIt* to a method and adding the method to *Point* is almost trivial. Within the *Point* object definition, *Drag* is just another method header:

```
Point = object(Location)
  Visible : Boolean;
  constructor Init(InitX, InitY : Integer);
  procedure Show; virtual;
  procedure Hide; virtual;
  function IsVisible : Boolean;
  procedure MoveTo(NewX, NewY : Integer);
  procedure Drag(DragBy : Integer); virtual;
end;
```

The position of *Drag*'s method header in the *Point* object definition is unimportant. Remember, methods can be declared in any order, but data fields *must* be defined before the first method declaration.

Changing the procedure *DragIt* to the method *Drag* is almost entirely a matter of applying *Point*'s scope to *DragIt*. In the *DragIt*



procedure, you had to specify *AnyFigure.Show*, *AnyFigure.GetX*, and so on. *Drag* is now a part of *Point*, so you no longer have to qualify method names. *AnyFigure.GetX* is now simply *GetX*, and so on. And of course, the *AnyFigure var* parameter is banished from the parameter line. The implied *Self* parameter now tells you which object instance is calling *Drag*.

The complete source code for FIGURES.PAS, including *Drag* implemented as a virtual method, is shown next:

```

unit Figures; { Virtual methods & polymorphic objects }

interface

uses Graph, Crt;

type
  Location = object
    X, Y : Integer;
    procedure Init(InitX, InitY : Integer);
    function GetX : Integer;
    function GetY : Integer;
  end;

  PointPtr = ^Point;

  Point = object(Location)
    Visible : Boolean;
    constructor Init(InitX, InitY : Integer);
    destructor Done; virtual;
    procedure Show; virtual;
    procedure Hide; virtual;
    function IsVisible : Boolean;
    procedure MoveTo(NewX, NewY : Integer);
    procedure Drag(DragBy : Integer); virtual;
  end;

  CirclePtr = ^Circle;

  Circle = object(Point)
    Radius : Integer;
    constructor Init(InitX, InitY : Integer;
      InitRadius : Integer);
    procedure Show; virtual;
    procedure Hide; virtual;
    procedure Expand(ExpandBy : Integer); virtual;
    procedure Contract(ContractBy : Integer); virtual;
  end;

```

```

implementation

{-----}
{ Location's method implementations:      }
{-----}

procedure Location.Init(InitX, InitY : Integer);
begin
    X := InitX;
    Y := InitY;
end;

function Location.GetX : Integer;
begin
    GetX := X;
end;

function Location.GetY : Integer;
begin
    GetY := Y;
end;

{-----}
{ Point's method implementations:        }
{-----}

constructor Point.Init(InitX, InitY : Integer);
begin
    Location.Init(InitX, InitY);
    Visible := False;
end;

destructor Point.Done;
begin
    Hide;
end;

procedure Point.Show;
begin
    Visible := True;
    PutPixel(X, Y, GetColor);
end;

procedure Point.Hide;
begin
    Visible := False;
    PutPixel(X, Y, GetBkColor);
end;

function Point.IsVisible : Boolean;
begin
    IsVisible := Visible;
end;

```

```

procedure Point.MoveTo(NewX, NewY : Integer);
begin
  Hide;
  X := NewX;
  Y := NewY;
  Show;
end;

function GetDelta(var DeltaX : Integer;
                  var DeltaY : Integer) : Boolean;

var
  KeyChar : Char;
  Quit : Boolean;

begin
  DeltaX := 0; DeltaY := 0; { 0 means no change in position; }
  GetDelta := True;       { True means return a delta   }
  repeat
    KeyChar := ReadKey;    { First, read the keystroke }
    Quit := True;         { Assume it's a useable key }

    case Ord(KeyChar) of
      0: begin             { 0 means an extended, 2-byte code }
        KeyChar := ReadKey; { Read second byte of code }
        case Ord(KeyChar) of
          72: DeltaY := -1; { Up arrow; decrement Y }
          80: DeltaY := 1;  { Down arrow; increment Y }
          75: DeltaX := -1; { Left arrow; decrement X }
          77: DeltaX := 1;  { Right arrow; increment X }
          else Quit := False; { Ignore any other code }
        end;
      end;
      13: GetDelta := False; { CR pressed means no delta }
      else Quit := False;   { Ignore any other keystroke }
    end;
  until Quit;
end;

procedure Point.Drag(DragBy : Integer);
var
  DeltaX, DeltaY : Integer;
  FigureX, FigureY : Integer;
begin
  Show;                { Display figure to be dragged }
  FigureX := GetX;    { Get the initial position of figure }
  FigureY := GetY;

```

```

    { This is the drag loop: }
while GetDelta(DeltaX, DeltaY) do
begin           { Apply delta to figure X,Y: }
    FigureX := FigureX + (DeltaX * DragBy);
    FigureY := FigureY + (DeltaY * DragBy);
    MoveTo(FigureX, FigureY); { And tell the figure to move }
end;
end;

{-----}
{ Circle's method implementations:           }
{-----}

constructor Circle.Init(InitX, InitY : Integer;
                        InitRadius : Integer);
begin
    Point.Init(InitX, InitY);
    Radius := InitRadius;
end;

procedure Circle.Show;
begin
    Visible := True;
    Graph.Circle(X, Y, Radius);
end;

procedure Circle.Hide;
var
    TempColor : Word;
begin
    TempColor := Graph.GetColor;
    Graph.SetColor(GetBkColor);
    Visible := False;
    Graph.Circle(X, Y, Radius);
    Graph.SetColor(TempColor);
end;

procedure Circle.Expand(ExpandBy : Integer);
begin
    Hide;
    Radius := Radius + ExpandBy;
    if Radius < 0 then Radius := 0;
    Show;
end;

```

```

procedure Circle.Contract(ContractBy : Integer);
begin
    Expand(-ContractBy);
end;

( No initialization section )

end.

```

By now, you should be thinking in terms of building functionality into objects in the form of methods rather than building procedures and passing objects to them as parameters. Ultimately you'll come to design programs in terms of activities that objects can do, rather than as collections of procedure calls that act upon passive data.

It's a whole new world.

## Object extensibility

---

The important thing to notice about toolbox units like FIGURES.PAS is that the object types and methods defined in the unit can be distributed to users in linkable .TPU form only, without source code. (Only a listing of the interface portion of the unit need be released.) Using polymorphic objects and virtual methods, the users of the .TPU file can still add features to it to suit their needs.

This novel notion of taking someone else's program code and adding functionality to it *without benefit of source code* is called *extensibility*. Extensibility is a natural outgrowth of inheritance: You inherit everything that all your ancestor types have, and then you add what new capability you need. Late binding lets the new meld with the old at run time, so the extension of the existing code is seamless and costs you no more in performance than a quick trip through the virtual method table.

The following program makes use of the *Figures* unit, and extends it by creating a new graphics figure object, *Arc*, as a descendant type of *Circle*. The object *Arc* could have been written long after FIGURES.PAS was compiled, and yet an object of type *Arc* can make use of inherited methods like *MoveTo* or *Drag* without any special considerations. Late binding and *Arc*'s virtual methods allows the *Drag* method to call *Arc*'s *Show* and *Hide* methods even though those methods might have been written long after *Point.Drag* itself was compiled:

```

program FigureDemo;      { Extending FIGURES.PAS with type Arc }
uses Crt, DOS, Graph, Figures;

type
  Arc = object(Circle)
    StartAngle, EndAngle : Integer;
    constructor Init(InitX, InitY : Integer;
                    InitRadius : Integer;
                    InitStartAngle, InitEndAngle : Integer);
    procedure Show; virtual;
    procedure Hide; virtual;
  end;

var
  GraphDriver : Integer;
  GraphMode : Integer;
  ErrorCode : Integer;
  AnArc : Arc;
  ACircle : Circle;

{-----}
{ Arc's method declarations:                }
{-----}

constructor Arc.Init(InitX, InitY : Integer;
                    InitRadius : Integer;
                    InitStartAngle, InitEndAngle : Integer);

begin
  Circle.Init(InitX, InitY, InitRadius);
  StartAngle := InitStartAngle;
  EndAngle := InitEndAngle;
end;

procedure Arc.Show;
begin
  Visible := True;
  Graph.Arc(X, Y, StartAngle, EndAngle, Radius);
end;

procedure Arc.Hide;
var
  TempColor : Word;
begin
  TempColor := Graph.GetColor;
  Graph.SetColor(GetBkColor);
  Visible := False;
  { Draw the arc in the background color to hide it }
  Graph.Arc(X, Y, StartAngle, EndAngle, Radius);
  SetColor(TempColor);
end;

```

```

{-----}
{ Main program:                               }
{-----}

begin
  GraphDriver := Detect; { Let the BGI determine what board
                          you're using }
  InitGraph(GraphDriver, GraphMode, '');
  if GraphResult <> GrOK then
  begin
    WriteLn('>>Halted on graphics error:',
            GraphErrorMsg(GraphDriver));
    Halt(1);
  end;

  { All descendants of type Point contain virtual methods and
  { *must* be initialized through a constructor call before use. }

  ACircle.Init(151, 82,      { Initial X,Y at 151,82 }
               50);         { Initial radius of 50 pixels }
  AnArc.Init(151, 82,      { Initial X,Y at 151,82 }
            25, 0, 90);    { Initial radius of 50 pixels }
                          { Start angle: 0; End angle: 90 }

  { Replace AnArc with ACircle to drag a circle instead of an }
  { arc. Press Enter to stop dragging and end the program.   }

  ACircle.Drag(5);        { Parameter is # of pixels to drag by }
  CloseGraph;
end.

```

## Static or virtual methods

In general, you should make methods virtual. Use static methods only when you want to optimize for speed and memory efficiency. The tradeoff, as you've seen, is in extensibility.

Let's say you are declaring an object named *Ancestor*, and within *Ancestor* you are declaring a method named *Action*. How do you decide whether *Action* should be virtual or static? Here's the rule of thumb: Make *Action* virtual if there is a possibility that some future descendant of *Ancestor* will override *Action*, and you want that future code to be accessible to *Ancestor*.

Now apply this rule to the graphics objects you've seen in this chapter. In this case, *Point* is the ancestor object type, and you must decide whether to make its methods static or virtual. Let's consider its *Show*, *Hide*, and *MoveTo* methods. Since each different type of figure has its own means of displaying and erasing itself, *Show* and *Hide* are overridden by each descendant figure. Moving

a graphics figure, however, seems to be the same for all descendants: Call *Hide* to erase the figure, change its *X,Y* coordinates, and then call *Show* to redisplay the figure in its new location. Since this *MoveTo* algorithm can be applied to any figure with a single anchor point at *X,Y*, it's reasonable to make *Point.MoveTo* a static method that is inherited by all descendants of *Point*; but *Show* and *Hide* are overridden and must be virtual so that *Point.MoveTo* can call its descendants' *Show* and *Hide* methods.

On the other hand, remember that if an object has any virtual methods, a VMT is created for that object type in the data segment and every object instance has a link to the VMT. Every call to a virtual method must pass through the VMT, while static methods are called directly. Though the VMT lookup is very efficient, calling a method that is static is still a little faster than calling a virtual one. And if there are no virtual methods in your object, then there is no VMT in the data segment and—more significantly—no link to the VMT in every object instance.

The added speed and memory efficiency of static methods must be balanced against the flexibility that virtual methods allow: extension of existing code long after that code is compiled. Keep in mind that users of your object type might think of ways to use it that you never dreamed of, which is, after all, the whole point.

---

## Dynamic objects

*The use of the word static does not relate in any way to static methods.*

All the object examples shown so far have had static instances of object types that were named in a `var` declaration and allocated in the data segment and on the stack.

```
var
  ACircle : Circle;
```

Objects can be allocated on the heap and manipulated with pointers, just as the closely related record types have always been in Pascal. Turbo Pascal 5.5 includes some powerful extensions to make dynamic allocation and deallocation of objects easier and more efficient.



Objects can be allocated as pointer referents with the *New* procedure:

```
var
  PCircle : ^Circle;

New(PCircle);
```

As with record types, *New* allocates enough space on the heap to contain an instance of the pointer's base type, and returns the address of that space in the pointer.

If the dynamic object contains virtual methods, it must then be initialized with a constructor call before any calls are made to its methods:

```
PCircle^.Init(600, 100, 30);
```

Method calls can then be made normally, using the pointer name and the reference symbol ^ (a caret) in place of the instance name that would be used in a call to a statically allocated object:

```
OldXPosition := PCircle^.GetX;
```

## Allocation and initialization with New

---

Turbo Pascal 5.5 extends the syntax of *New* to allow a more compact and convenient means of allocating space for an object on the heap and initializing the object with one operation. *New* can now be invoked with two parameters: the pointer name as the first parameter, and the constructor invocation as the second parameter:

```
New(PCircle, Init(600, 100, 30));
```

When you use this extended syntax for *New*, the constructor *Init* actually performs the dynamic allocation, using special entry code generated as part of a constructor's compilation. The instance name cannot precede *Init*, since at the time *New* is called, the instance being initialized with *Init* does not yet exist. The compiler identifies the correct *Init* method to call through the type of the pointer passed as the first parameter.

*New* has also been extended to allow it to act as a function returning a pointer value. The parameter passed to *New* is the *type* of the pointer to the object rather than the pointer variable itself:

```
type
  ArcPtr = ^Arc;
```

```

var
  PArc : ArcPtr;

  PArc := New(ArcPtr);

```

Note that with version 5.5, the function-form extension to *New* applies to *all* data types, not only to object types:

```

type
  CharPtr = ^Char; { Char is not an object type... }

var
  PChar : CharPtr;

  PChar := New(CharPtr);

```

The function form of *New*, like the procedure form, can also take the object type's constructor as a second parameter:

```

  PArc := New(ArcPtr, Init(600, 100, 25, 0, 90));

```

*A new standard procedure, Fail, helps you do error recovery in constructors; see page 109.*

A parallel extension to *Dispose* has been defined for Turbo Pascal 5.5, as fully explained in the following sections.

## Disposing dynamic objects

Just like traditional Pascal records, objects allocated on the heap can be deallocated with *Dispose* when they are no longer needed:

```

  Dispose(PCircle);

```

There can be more to getting rid of an unneeded dynamic object than just releasing its heap space, however. An object can contain pointers to dynamic structures or objects that need to be released or "cleaned up" in a particular order, especially when elaborate dynamic data structures are involved. Whatever needs to be done to clean up a dynamic object in an orderly fashion should be gathered together in a single method so that the object can be eliminated with one method call:

```

  MyComplexObject.Done;

```

*We suggest the identifier Done for cleanup methods that "close up shop" once an object is no longer needed.*

The *Done* method should encapsulate all the details of cleaning up its object and all the data structures and objects nested within it.

It is legal and often useful to define multiple cleanup methods for a given object type. Complex objects might need to be cleaned up in different ways depending on how they were allocated or used, or depending on what mode or state the object was in when it was cleaned up.

## Destructors

---

Turbo Pascal 5.5 provides a special type of method called a *destructor* for cleaning up and disposing of dynamically allocated objects. A destructor combines the heap deallocation step with whatever other tasks are necessary for a given object type. As with any method, multiple destructors can be defined for a single object type.

A destructor is defined with all the object's other methods in the object type definition:

```
Point = object(Location)
  Visible : Boolean;
  Next : PointPtr;
  constructor Init(InitX, InitY : Integer);
  destructor Done; virtual;
  procedure Show; virtual;
  procedure Hide; virtual;
  function IsVisible : Boolean;
  procedure MoveTo(NewX, NewY : Integer);
  procedure Drag(DragBy : Integer); virtual;
end;
```

Destructors can be inherited, and they can be either static or virtual. Because different shutdown tasks are usually required for different object types, it is a good idea *always* to make destructors virtual, so that in every case the correct destructor is executed for its object type.

Keep in mind that the reserved word **destructor** is not needed for every cleanup method, even if the object type definition contains virtual methods. Destructors really operate only on dynamically allocated objects. In cleaning up a dynamically allocated object, the destructor performs a special service: It guarantees that the correct number of bytes of heap memory are always released. There is, however, no harm in using destructors with statically allocated objects; in fact, by not giving an object type a destructor, you prevent objects of that type from getting the full benefit of Turbo Pascal's dynamic memory management.

Destructors really come into their own when polymorphic objects must be cleaned up and their heap allocation released. A polymorphic object is an object that has been assigned to an ancestor type by virtue of Turbo Pascal's extended type compatibility rules. In the running example of graphics figures, an instance of object

type *Circle* assigned to a variable of type *Point* is an example of a polymorphic object. These rules govern pointers to objects as well; a pointer to *Circle* can be freely assigned to a pointer to type *Point*, and the referent of that pointer is also a polymorphic object.

The term *polymorphic* is appropriate because the code using the object doesn't know at compile time precisely what type of object is on the end of the string—only that the object is one of a hierarchy of objects descended from the specified type.

The size of object types differ, obviously. So when it comes time to clean up a polymorphic object allocated on the heap, how does *Dispose* know how many bytes of heap space to release? No information on the size of the object can be gleaned from a polymorphic object at compile time.

The destructor solves the problem by going to the place where the information *is* stored: in the instance variable's VMT. In every object type's VMT is the size in bytes of the object type. The VMT for any object is available through the invisible *Self* parameter passed to the method on any method call. A destructor is just a special kind of method, and it receives a copy of *Self* on the stack when an object calls it. So while an object might be polymorphic at *compile time*, it is never polymorphic at run time, thanks to late binding.

To perform this late-bound memory deallocation, the destructor must be called as part of the extended syntax for the *Dispose* procedure:

```
Dispose(PPoint, Done);
```

(Calling a destructor outside of a *Dispose* call does no automatic deallocation at all.) What happens here is that the destructor of the object pointed to by *PPoint* is executed as a normal method call. As the last thing it does, however, the destructor looks up the size of its instance type in the instance's VMT, and passes the size to *Dispose*. *Dispose* completes the shutdown by deallocating the correct number of bytes of heap space that had previously belonged to *PPoint*<sup>^</sup>. The number of bytes released is correct whether *PPoint* points to an instance of type *Point* or to one of *Point*'s descendant types like *Circle* or *Arc*.

Note that the destructor method itself can be empty and still perform this service:

```
destructor AnObject.Done;  
begin  
end;
```

What performs the useful work in this destructor is not the method body but the epilog code generated by the compiler in response to the reserved word **destructor**. In this, it is similar to a unit that exports nothing, but performs some “invisible” service by executing an initialization section before program startup. The action is all behind the scenes.

## An example of dynamic object allocation

---

The final example program provides some practice in the use of objects allocated on the heap, including the use of destructors for object deallocation. The program shows how a linked list of graphics objects might be created on the heap and cleaned up using destructor calls when they are no longer required.

Building a linked list of objects requires that each object contain a pointer to the next object in the list. Type *Point* contains no such pointer. The easy way out would be to add a pointer to *Point*, and in doing so ensure that all *Point*'s descendant types also inherit the pointer. However, adding anything to *Point* requires that you have the source code for *Point*, and as said earlier, one advantage of object-oriented programming is the ability to extend existing objects without necessarily being able to recompile them.

See page 58 for the  
declarations of *List* and  
*Node*.

The solution that requires no changes to *Point* creates a new object type not descended from *Point*. Type *List* is a very simple object whose purpose is to head up a list of *Point* objects. Because *Point* contains no pointer to the next object in the list, a simple record type, *Node*, provides that service. *Node* is even simpler than *List*, in that it is not an object, has no methods, and contains no data except a pointer to type *Point* and a pointer to the next node in the list.

*List* has a method that allows it to add new figures to its linked list of *Node* records by inserting a new instance of *Node* immediately after itself, as a referent to its *Nodes* pointer field. The *Add* method takes a pointer to a *Point* object, rather than a *Point* object itself. Because of Turbo Pascal 5.5's extended type compatibility, pointers to any type descended from *Point* can also be passed in the *Item* parameter to *List.Add*.

Program *ListDemo* declares a static variable, *AList*, of type *List*, and builds a linked list with three nodes. Each node points to a different graphics figure that is either a *Point* or one of its descendants. The number of bytes of free heap space is reported before any of the dynamic objects are created, and then again after all have been created. Finally, the whole structure, including the three *Node* records and the three *Point* objects, are cleaned up and removed from the heap with a single destructor call to the static *List* object, *AList*.

Figure 1.2  
Layout of program  
*ListDemo*'s data structures

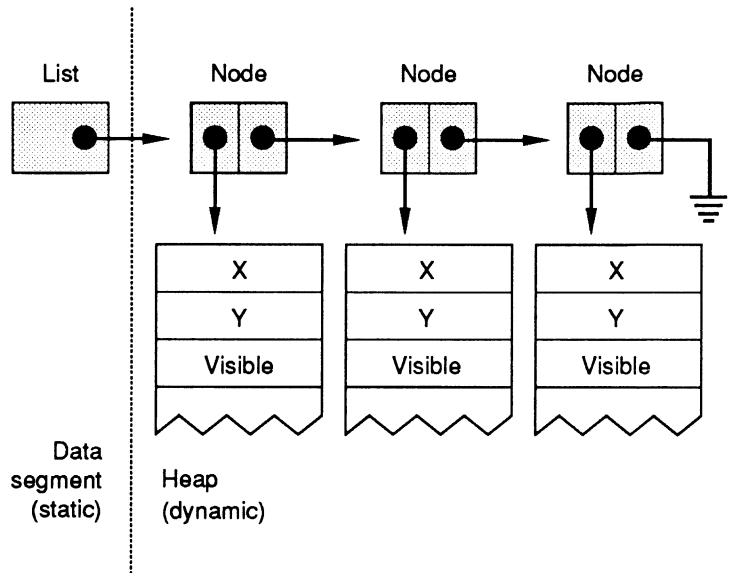

Disposing of a complex data structure on the heap

This destructor, *List.Done*, is worth a close look. Shutting down a *List* object involves disposing of three different kinds of structures: the polymorphic graphics figure objects in the list, the *Node* records that hold the list together, and (if it is allocated on the heap) the *List* object that heads up the list. The whole process is invoked by a single call to *AList*'s destructor:

```
AList.Done;
```

The code for the destructor merits examination:

```

destructor List.Done;
var
  N: NodePtr;
begin
  while Nodes <> nil do
  begin
    N := Nodes;
    Dispose(N^.Item, Done);
    Nodes := N^.Next;
    Dispose(N);
  end;
end;

```

The list is cleaned up from the list head by the “hand-over-hand” algorithm, metaphorically similar to pulling in the string of a kite: Two pointers, the *Nodes* pointer within *AList* and a working pointer *N*, alternate their grasp on the list while the first item in the list is disposed of. A dispose call deallocates storage for the first *Point* object in the list (*Item*<sup>^</sup>); then *Nodes* is advanced to the next *Node* record in the list by the statement *Nodes := N^.Next*; the *Node* record itself is deallocated; and the process repeats until the list is gone.

The important thing to note in the destructor *Done* is the way the *Point* objects in the list are deallocated:

```
Dispose(N^.Item, Done);
```

Here, *N^.Item* is the first *Point* object in the list, and the *Done* method called is its destructor. Keep in mind that the actual type of *N^.Item*<sup>^</sup> is not necessarily *Point*, but could as well be any descendant type of *Point*. The object being cleaned up is a polymorphic object, and no assumptions can be made about its actual size or exact type at compile time. In the earlier call to *Dispose*, once *Done* has executed all the statements it contains, the “invisible” epilog code in *Done* looks up the size of the object instance being cleaned up in the object’s VMT. *Done* passes that size to *Dispose*, which then releases the exact amount of heap space the polymorphic object actually occupied.

Remember that polymorphic objects must be cleaned up this way, through a destructor call passed to *Dispose*, if the correct amount of heap space is to be reliably released.

In the example program, *AList* is declared as a static variable in the data segment. *AList* could as easily have been itself allocated on the heap, and anchored to reality by a pointer of type *ListPtr*. If the head of the list had been a dynamic object too, disposing of

the structure would have been done by a destructor call executed within *Dispose*:

```
var
  PList : ListPtr;
...
Dispose(PList,Done);
```

Here, *Dispose* calls the destructor method *Done* to clean up the structure on the heap. Then, once *Done* is finished, *Dispose* deallocates storage for *PList*'s referent, removing the head of the list from the heap as well.

The following program uses the same FIGURES.PAS unit described on page 43. It implements an *Arc* type as a descendant of *Point*, creates a *List* object heading up a linked list of three polymorphic objects compatible with *Point*, and then disposes of the whole dynamic data structure with a single destructor call to *AList.Done*.

```
program ListDemo; { Dynamic objects & destructors }
uses Graph, Figures;

type
  ArcPtr = ^Arc;
  Arc = object(Circle)
    StartAngle, EndAngle : Integer;
    constructor Init(InitX, InitY : Integer;
                    InitRadius : Integer;
                    InitStartAngle, InitEndAngle : Integer);
    procedure Show; virtual;
    procedure Hide; virtual;
  end;

  NodePtr = ^Node;
  Node = record
    Item : PointPtr;
    Next : NodePtr;
  end;

  ListPtr = ^List;
  List = object
    Nodes : NodePtr;
    constructor Init;
    destructor Done; virtual;
    procedure Add(Item : PointPtr);
    procedure Report;
  end;
```



```

var
    GraphDriver : Integer;
    GraphMode : Integer;
    Temp : String;
    AList : List;
    PArc : ArcPtr;
    PCircle : CirclePtr;
    RootNode : NodePtr;

{-----}
{ Procedures that are not methods:           }
{-----}

procedure OutTextLn(TheText : String);
begin
    OutText(TheText);
    MoveTo(0, GetY + 12);
end;

procedure HeapStatus(StatusMessage : String);
begin
    Str(MemAvail : 6, Temp);
    OutTextLn(StatusMessage + Temp);
end;

{-----}
{ Arc's method implementations:             }
{-----}

constructor Arc.Init(InitX, InitY : Integer;
                    InitRadius : Integer;
                    InitStartAngle, InitEndAngle : Integer);
begin
    Circle.Init(InitX, InitY, InitRadius);
    StartAngle := InitStartAngle;
    EndAngle := InitEndAngle;
end;

procedure Arc.Show;
begin
    Visible := True;
    Graph.Arc(X, Y, StartAngle, EndAngle, Radius);
end;

```

```

procedure Arc.Hide;
var
  TempColor : Word;
begin
  TempColor := Graph.GetColor;
  Graph.SetColor(GetBkColor);
  Visible := False;
  Graph.Arc(X, Y, StartAngle, EndAngle, Radius);
  SetColor(TempColor);
end;

{-----}
{ List's method implementations:           }
{-----}

constructor List.Init;
begin
  Nodes := nil;
end;

destructor List.Done;
var
  N : NodePtr;
begin
  while Nodes <> nil do
  begin
    N := Nodes;
    Dispose(N^.Item, Done);
    Nodes := N^.Next;
    Dispose(N);
  end;
end;

procedure List.Add(Item : PointPtr);
var
  N : NodePtr;
begin
  New(N);
  N^.Item := Item;
  N^.Next := Nodes;
  Nodes := N;
end;

```

```

procedure List.Report;
var
    Current : NodePtr;
begin
    Current := Nodes;
    while Current <> nil do
        begin
            Str(Current^.Item^.GetX : 3, Temp);
            OutTextLn('X = '+Temp);
            Str(Current^.Item^.GetY : 3, Temp);
            OutTextLn('Y = '+Temp);
            Current := Current^.Next;
        end;
    end;

{-----}
{ Main program:                               }
{-----}

begin
    { Let the BGI determine what board you're using: }
    InitGraph(GraphDriver, GraphMode, '');
    if GraphResult <> GrOK then
        begin
            WriteLn('>>Halted on graphics error: ',
                    GraphErrorMsg(GraphDriver));
            Halt(1);
        end;

    HeapStatus('Heap space before list is allocated: ');

    { Create a list }
    AList.Init;

    { Now create and add several figures to it in one operation }
    AList.Add(New(ArcPtr, Init(151, 82, 25, 200, 330)));
    AList.Add(New(CirclePtr, Init(400, 100, 40)));
    AList.Add(New(CirclePtr, Init(305, 136, 5)));

    { Traverse the list and display X,Y of the list's figures }
    AList.Report;

    HeapStatus('Heap space after list is allocated ');

    { Deallocate the whole list with one destructor call }
    AList.Done;

```

```
HeapStatus('Heap space after list is cleaned up: ');  
OutText('Press Enter to end program: ');  
ReadLn;  
  
CloseGraph;  
end.
```

## Where to now?

---

As with any aspect of computer programming, you don't get better at object-oriented programming by reading about it; you get better at it by doing it. Most people, on first exposure to object-oriented programming, are heard to mutter "I don't get it" under their breath. The "Aha!" comes later, when in the midst of putting their own objects in place, the whole concept comes together in the sort of perfect moment we used to call an epiphany. Like the face of woman emerging from a Rorschach inkblot, what was obscure before at once becomes obvious, and from then on it's easy.

The best thing to do for your first object-oriented project is to take the FIGURES.PAS unit shown on page 43 (you have it on disk) and extend it. Points, circles, and arcs are by no means enough. Create objects for lines, rectangles, and squares. When you're feeling more ambitious, create a pie-chart object using a linked list of individual pie-slice figures.

One more subtle challenge is to implement objects with relative position. A relative position is an offset from some base point, expressed as a positive or negative difference. A point at relative coordinates  $-17,42$  is 17 pixels to the left of the base point, and 42 pixels down from that base point. Relative positions are necessary to combine figures effectively into single larger figures, since multiple-figure combination figures cannot always be tied together at each figure's anchor point. Better to define an *RX* and *RY* field in addition to anchor point *X,Y*, and have the final position of the object onscreen be the sum of its anchor point and relative coordinates.

Once you've had your "Aha!" start building object-oriented concepts into your everyday programming chores. Take some existing utilities you use every day and rethink them in object oriented terms. Take another look at your hodgepodge of procedure libraries and try to see the objects in them—then

rewrite the procedures in object form. You'll find that libraries of objects are much easier to reuse in future projects. Very little of your initial investment in programming effort will ever be wasted. You will rarely have to rewrite an object from scratch. If it will serve as is, use it. If it lacks something, extend it. But if it works well, there's no reason to throw away any of what's there.

## Conclusion

---

Object-oriented programming is a direct response to the complexity of modern applications, complexity that has often made many programmers throw up their hands in despair. Inheritance and encapsulation are extremely effective means for managing complexity. (It's the difference between having ten thousand insects classified in a taxonomy chart, and ten thousand insects all buzzing around your ears.) Far more than structured programming, object-orientation imposes a rational order on software structures that, like a taxonomy chart, imposes order without imposing limits.

Add to that the promise of the extensibility and reusability of existing code, and the whole thing begins to sound almost too good to be true. Impossible, you think?

Hey, this is Turbo Pascal.

"Impossible" is undefined.



## Object-oriented debugging

To meet the needs of the object-oriented revolution, both the Turbo Pascal integrated development environment (IDE) and Turbo Debugger have been enhanced to support object-oriented programming. To use these object-oriented features, you must have version 5.5 of Turbo Pascal and version 1.5 of Turbo Debugger.

### Object-oriented debugging in the IDE

---

*You don't need to make any special preparations to debug an object-oriented program.*

Working with objects under the IDE involves two functional areas: stepping and tracing through method calls, and examining object data. The integrated debugger "understands" objects and handles them automatically in a fashion consistent with related language components like procedures and records.

#### Stepping and tracing method calls

---

A method call is treated by the IDE as an ordinary procedure or function call. *F8* (Step) treats a method call as an indivisible unit, and executes it without displaying the method's internal code; whereas *F7* (Trace) loads the method's code if it's available, and traces through the method's statements.

There is no difference between tracing static method calls and tracing virtual method calls. Virtual method calls are resolved at run time, but because debugging happens at run time, there is no

ambiguity, and the integrated debugger always knows the correct method to execute next.

The Call Stack window displays the names of methods prefixed by the object type that defines the method (for example, *Circle.Init* rather than simply *Init*).

---

## Objects in the Evaluate window

When they are displayed in the Evaluate window, objects appear in a fashion very similar to records. All the same format specifiers apply, and all expressions that would be valid for records are valid for objects.

Only the data fields are displayed when the object name as a whole is presented to Evaluate. However, when the specific method name is evaluated, as in

```
ACircle.MoveTo
```

a pointer value is displayed indicating the address of the method's code. This is true for both static and virtual methods. The integrated debugger handles virtual method lookup transparently through the virtual method table (VMT), and the address of a virtual method for a given object instance is the true address of the correct method code for that instance.

When it is tracing inside a method, the IDE "knows" about the scope and presence of the *Self* parameter. You can evaluate or watch *Self*, and you can follow it with format specifiers and field or method qualifiers.

---

## Objects in the Watch window

An object can be added to the Watch window just as a record can; all expressions that would be valid for records are also valid for objects.

---

## Expressions in the Find Procedure command

Turbo Pascal 5.5 allows the entry of expressions at the prompt for the Find Procedure command of the Debug menu. To be legal, an expression must evaluate to an address in the code segment. Note that this applies to procedural variables and parameters as well as to object methods.



# Turbo Debugger

---

As with the integrated debugger in Turbo Pascal's integrated development environment (IDE), Turbo Debugger version 1.5 has been enhanced to allow you to debug object-oriented programs. Like the IDE, Turbo Debugger is smart about objects.

## Stepping and tracing method calls

---

During Tracing (*F7*) or Stepping (*F8*), Turbo Debugger treats methods just as if they were functions or procedures. *F7* traces into the method's source code if it's available, while *F8* treats the method call as if it were one statement and steps over it.

Like the IDE, Turbo Debugger correctly handles late binding of virtual methods: It always executes and displays the correct code. And Turbo Debugger's Stack window displays the names of methods prefixed by the object type that defines the method.

## Scope

*The examples of fully qualified expressions in this discussion are also valid in the Turbo Pascal IDE's Watch and Evaluate windows and Find Procedure command.*

---

The "scope" of a symbol is where the debugger looks for that symbol. Turbo Debugger uses the current cursor position to decide a current scope. (See the section, "Implied scope for expression evaluation," in Chapter 9 of the *Turbo Debugger* manual.) If no Module window is open, Turbo Debugger derives the current scope from the CS:IP values in the CPU window. If a symbol is not in the current scope, you can fully qualify its "path" and Turbo Debugger will find it for you. The following syntax describes how to fully qualify an identifier's scope. Brackets [ ] indicate optional items, while braces { } indicate optional items that can be repeated:

```
[Unit.] [ObjectType.Method.] {Proc.} [Var]
```

Here are some examples that don't involve objects and methods:

- *AVar*: Variable *AVar* accessible in the current scope.
- *AProc*: Procedure *AProc* accessible in the current scope.
- *AProc.AVar*: Local variable *AVar* accessible in procedure *AProc* accessible in the current scope.
- *AProc.ANestedProc*: Procedure *ANestedProc* accessible in procedure *AProc* accessible in the current scope.

- *AUnit.AProc.AVar*: Local variable *AVar* accessible in procedure *AProc* accessible in unit *AUnit*.
- *AUnit.AProc.ANestedProc.AVar*: Local variable *AVar* accessible in procedure *ANestedProc* accessible in procedure *AProc* accessible in unit *AUnit*.

Here are some examples that involve objects and methods:

- *AnInstance*: Instance *AnInstance* accessible in the current scope.
- *AnInstance.AField*: Field *AField* accessible in instance *AnInstance* accessible in the current scope.
- *AnObjectType.AMethod*: Method *AMethod* accessible in object type *AnObjectType* accessible in the current scope.
- *AnInstance.AMethod*: Method *AMethod* accessible in instance *AnInstance* accessible in the current scope.
- *AUnit.AnInstance.AField*: Field *AMethod* accessible in instance *AnInstance* accessible in unit *AUnit*.
- *AUnit.AnObjectType.AMethod*: Method *AMethod* accessible in object type *AnObjectType* accessible in unit *AUnit*.
- *AUnit.AnObjectType.AMethod.ANestedProc.AVar*: Local variable *AVar* accessible in procedure *ANestedProc* accessible in method *AMethod* accessible in object type *AnObjectType* accessible in unit *AUnit*.

You can enter such qualified identifier expressions anywhere an expression is valid (including in the Evaluate and Watch windows), for example, when you're changing an expression in an Inspector window or using the local menu in the Module window to Goto a method or procedure address in the source code.

## Evaluate Window

---

Turbo Debugger's Evaluate window treats an object instance just like the IDE does: The fields are displayed and any format specifier that can be used in evaluating a record can also be used in evaluating an object instance.

When you're tracing inside a method, Turbo Debugger knows about the scope and presence of the *Self* parameter. You can evaluate (or watch) *Self*, and you can follow it with format specifiers and field or method qualifiers.

## Calling methods in the Evaluate window

Turbo Debugger also lets you call a method from inside the Evaluate window. Just type the object instance name followed by a dot, followed by the method name, followed by the actual parameters (or empty parentheses if there are no parameters). With these declarations,

```
type
  Point = object
    X, Y : Integer;
    Visible : Boolean;
    constructor Init(InitX, InitY : Integer);
    destructor Done; virtual;
    procedure Show; virtual;
    procedure Hide; virtual;
    procedure MoveTo(NewX, NewY : Integer);
  end;

var
  APoint : Point;
```

you could enter any of these expressions in Turbo Debugger's Evaluate window:

Expression	Result
<i>APoint.X</i>	5 (\$5) : Integer
<i>APoint</i>	(5,23,FALSE) : Point
<i>APoint.MoveTo</i>	@6F4F : 00BE
<i>APoint.MoveTo(10, 10)</i>	calls method <i>MoveTo</i>
<i>APoint.Show()</i>	calls method <i>Show</i>

Note that you cannot execute constructor or destructor methods in the Evaluate window.

---

## Watch window

An object can be added to the Watch window just as a record and the same expressions that can be entered in the Evaluate window can also be entered in the Watch window.

---

## The Object Hierarchy window

Turbo Debugger provides an entirely new window for examining object hierarchies. You can bring up the Object Hierarchy window by pressing *H* in the View menu.

Use *Tab* to move between the two panes.

The two-paned Object Hierarchy window displays information on object *types* rather than object instances. The left pane lists in alphabetical order the object types used by the module being debugged. The right pane shows all objects in their hierarchies, using a line graphic that places the base object type at the left margin of the pane and displays descendant objects beneath and to the right of the base object, with lines indicating ancestor and descendant relationships.

The object type list pane

The left pane provides an alphabetical list of all object types used by the current module. It supports an incremental match feature to eliminate the need to cursor through large lists of object types: When the highlight bar is in the left pane, simply start typing the name of the object type you're looking for. At each keypress, the pane highlights the first object type matching all keys pressed up to that point.

Press *Enter* to open an Object Type Inspector window for the highlighted object type. Object Type Inspectors are described on page 71.

The local menu

Press *Alt-F10* to display the local menu for the pane. You can use the *Ctrl*-key shortcuts if you've enabled shortcuts with TDINST. This local menu contains two items:

- **Inspect (*Ctrl-I*):** Displays an object type inspector window for the highlighted object type.
- **Tree (*Ctrl-T*):** Moves to the right pane of the window, in which the object hierarchy tree is displayed, and places the highlight bar on the object type that was highlighted in the left pane.

The hierarchy tree pane

The right pane displays the hierarchy tree for all objects used by the current module. Ancestor and descendant relationships are indicated by lines, with descendant objects to the right of and below their ancestors.

To locate a single object type in a complex hierarchy tree, go back to the left pane and use the incremental search feature; then choose the **Tree** item from the local menu to move back into the hierarchy tree. The matched type appears under the highlight bar.

When you press *Enter*, an Object Type Inspector window appears for the highlighted object type.

The hierarchy tree's local menu (*Alt-F10* in the right pane) has only one item: *Inspect*. When you choose it, an Object Type Inspector window appears for the highlighted type. However, a faster and easier method is simply to press *Enter* when you wish to inspect the highlighted object type.

---

## The Object Type Inspector window

Turbo Debugger provides a new type of Inspector window to allow you to inspect the details of an object type: *the Object Type Inspector window*. The window summarizes type information, but does not reference any particular object instance.

The window is divided into two panes horizontally, with the top pane listing the data fields of the object type, and the bottom pane listing the method names and (if the selected method is a function) the function return type. Use the *Tab* key to move between the two panes of the Object Type Inspector window.

If the highlighted data field is an object type or a pointer to an object type, pressing *Enter* opens another Object Type Inspector window for the highlighted type. (This action is identical to selecting the *Inspect* command in the local menu for this window.) In this way, complex nested structures of objects can be inspected quickly with a minimum of keystrokes.

For brevity's sake, method parameters are not shown in the Object Type Inspector window. To examine method parameters, highlight the method and press *Enter*. A Method Inspector window appears. The top pane of the window displays the code address for the object type's implementation of the selected method, and the names and types of all method parameters. The bottom pane of the window indicates whether the method is a procedure or a function.

Pressing *Enter* from anywhere within the Method Inspector window brings the Module window to the foreground, with the cursor at the code that implements the method being inspected.

As with standard inspectors, *Esc* closes the current Inspector window and *F3* closes them all.

The local menus Pressing *Alt-F10* brings up the local menu for either pane. If *Ctrl*-key shortcuts are enabled (through *TDINST*), you can get to a local menu item by pressing *Ctrl* and the first letter of the item. The top pane contains these menu items:

- **Inspect (Ctrl-I):** If the highlighted field is an object type or a pointer to one, a new Object Type Inspector window is opened for the highlighted field.
- **Hierarchy (Ctrl-H):** Opens an Object Hierarchy window for the object type being inspected. The Object Hierarchy window is described on page 69.
- **Show Inherited (Ctrl-S):** *Yes* is the default value of this toggle. When it is set to *Yes*, all data fields are shown, whether they are defined within the type of the inspected object or inherited from an ancestor object type. When it is set to *No*, only those fields defined within the type of the inspected object are displayed.

These are the local menu items for the bottom pane:

- **Inspect (Ctrl-I):** A Function Inspector window is opened for the highlighted method. If you press *Ctrl-I* when the cursor is positioned over the address shown in the Function Inspector window, the Module window is brought to the foreground with the cursor at the code implementing the method being inspected.
- **Hierarchy (Ctrl-H):** Opens an Object Hierarchy window for the object type being inspected. The Object Hierarchy window is described on page 69.
- **Show Inherited (Ctrl-S):** *Yes* is the default value of this toggle. When it is set to *Yes*, all methods are shown, whether they are defined within the type of the inspected object or inherited from an ancestor object type. When it is set to *No*, only those methods defined within the type of the inspected object are displayed.

## Object Instance Inspector window

*Bring up this window by placing your cursor on an object instance in the Module window, then pressing Ctrl-I.*

---

Object Type Inspector windows provide information about object types, but say nothing about the data contained in a particular object instance at a particular time during program execution. Turbo Debugger provides an extended form of the familiar record inspector window specifically to inspect object instances.

Most Turbo Debugger data record Inspector windows have two panes: a top pane summarizing the record's field names and their current values, and a bottom pane displaying the type of the field highlighted in the top pane. An Object Instance Inspector window provides both of those panes, and also a third pane between them.

This new pane summarizes the object instance's methods with the code address of each. (The code address takes into account polymorphic objects and the VMT.)

**Local menus** Each of the top two panes of the Object Instance Inspector window has its own local menu, displayed by pressing *Alt-F10* in that pane. Again, you can use the *Ctrl*-key shortcuts to get to individual menu items if you've enabled shortcuts with TDINST. As with Record Inspector windows, the bottom pane serves only to display the type of the highlighted field, and doesn't have a local menu.

The top pane, which summarizes the data fields for an object, has the following local menu commands:

- **Range (Ctrl-R):** This command is unchanged from earlier versions. It allows the range of array items to be displayed. If the inspected item is not an array or a pointer, the item cannot be accessed.
- **Change (Ctrl-C):** By choosing this command, you can load a new value into the highlighted data field. This command is also unchanged from earlier versions of Turbo Debugger.
- **Methods (Ctrl-M):** This command is new to Turbo Debugger 1.5. It is a *Yes/No* toggle, with *Yes* as the default condition. When it is set to *Yes*, methods are summarized in the middle pane. When it is set to *No*, the middle pane does not appear.
- **Show Inherited (Ctrl-S):** Again, an item new to Turbo Debugger 1.5, and also a *Yes/No* toggle. When it is set to *Yes*, all data fields and methods are shown, whether they are defined within the type of the inspected object, or inherited from an ancestor object type. When it is set to *No*, only those fields and methods defined within the type of the inspected object are displayed.
- **Inspect (Ctrl-I):** As with earlier versions of Turbo Debugger, choosing this command opens a Data Inspector window on the highlighted field. Pressing *Enter* over a highlighted field does the same thing.
- **Descend (Ctrl-D):** This command has not changed from earlier versions of Turbo Debugger. The highlighted item takes the place of the item in the current Inspector window. No new Inspector window is opened. However, you cannot return to the previously inspected field, as you could if you had used the Inspect option.

*This toggle is remembered by the next inspector to be opened.*

*Use Descend when you're tracing through a complicated data structure and would prefer not to open a separate Inspector window for each item inspected.*

- **New Expression (*Ctrl-N*):** No change from earlier versions. This command prompts you for a new data item or expression to inspect. The new item replaces the current one in the window; it doesn't open another window.
- **Hierarchy (*Ctrl-H*):** This command is new to Turbo Debugger 1.5. When you choose it, an Object Hierarchy window opens. The full description of this window appears on 69.

The middle pane summarizes the methods of an object. The only difference between the method pane's local menu and the local menu for the data field (top) pane is the absence of the Change command. Unlike data fields, methods cannot be changed during execution, so there is no need for this command.

The bottom pane displays the type of the item highlighted in the upper two windows.

## New error messages

---

### **Constructors and destructors cannot be called.**

You probably tried to evaluate a method that's either a constructor or a destructor. This is not allowed.

### **Not an object Pascal program.**

You tried to open an Object Hierarchy window, but there are no objects in your program.



## Turbo Pascal 5.5 language definition

The material in this chapter comprises additions to chapters 1 through 11 of the *Turbo Pascal Reference Guide* for Turbo Pascal 5.0. Use the references in the margin of this chapter to look up related material in your 5.0 manuals.

### New reserved words

---

*See Chapter 1, "Tokens and Constants," in the Reference Guide.*

Turbo Pascal version 5.5 adds the following new reserved words:

**constructor**  
**destructor**  
**object**  
**virtual**

User-defined identifiers are not allowed to use the same spelling as these, or the existing reserved words.

### Object types

---

*See Chapter 3, "Types," in the Reference Guide.*

An object type is a structure consisting of a fixed number of components. Each component is either a *field*, which contains data of a particular type, or a *method*, which performs an operation on the object. Analogous to a variable declaration, the declaration of a field specifies the data type of the field and an identifier that names the field; and analogous to a procedure or function

declaration, the declaration of a method specifies a procedure, function, constructor, or destructor heading.

An object type can *inherit* components from another object type. If *T2* inherits from *T1*, then *T2* is a *descendant* of *T1*, and *T1* is an *ancestor* of *T2*.

Inheritance is transitive, that is, if *T3* inherits from *T2*, and *T2* inherits from *T1*, then *T3* also inherits from *T1*. The *domain* of an object type consists of itself and all its descendants.

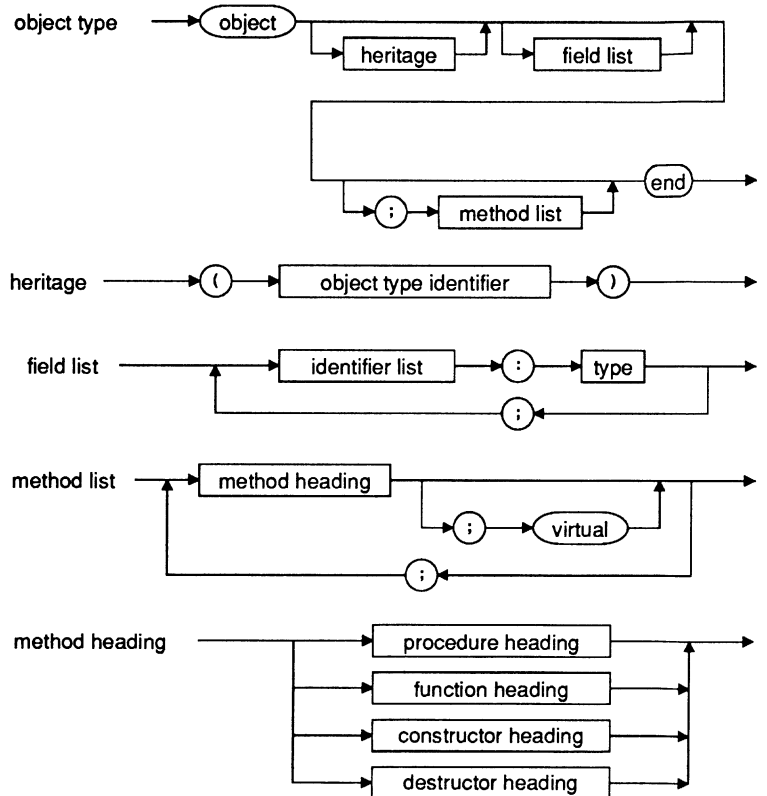

The following code shows examples of object type declarations. These declarations are referred to by other examples throughout this chapter.

```

type
Point = object
  X, Y : Integer;
end;

Rect = object
  A, B : Point;
  procedure Init(XA, YA, XB, YB : Integer);
  procedure Copy(var R : Rect);
  procedure Move(DX, DY : Integer);
  procedure Grow(DX, DY : Integer);
  procedure Intersect(var R : Rect);
  procedure Union(var R : Rect);
  function Contains(P : Point) : Boolean;
end;

StringPtr = ^String;
FieldPtr = ^Field;

Field = object
  X, Y, Len : Integer;
  Name : StringPtr;
  constructor Copy(var F : Field);
  constructor Init(FX, FY, FLen : Integer; FName : String);
  destructor Done; virtual;
  procedure Display; virtual;
  procedure Edit; virtual;
  function GetStr : String; virtual;
  function PutStr(S : String) : Boolean; virtual;
end;

StrFieldPtr = ^StrField;

StrField = object(Field)
  Value : StringPtr;
  constructor Init(FX, FY, FLen : Integer; FName : String);
  destructor Done; virtual;
  function GetStr : String; virtual;
  function PutStr(S : String) : Boolean; virtual;
  function Get : String;
  procedure Put(S : String);
end;

```

```

NumFieldPtr = ^NumField;

NumField = object(Field)
  Value, Min, Max : Longint;
  constructor Init(FX, FY, FLen : Integer; FName : String;
    FMin, FMax : Longint);
  function GetStr : String; virtual;
  function PutStr(S : String) : Boolean; virtual;
  function Get : Longint;
  procedure Put(N : Longint);
end;

ZipFieldPtr = ^ZipField;

ZipField = object(NumField)
  function GetStr : String; virtual;
  function PutStr(S : String) : Boolean; virtual;
end;

```

Contrary to other types, an object type can be declared only in a type declaration part in the outermost scope of a program or unit. Thus, an object type cannot be declared in a variable declaration part or within a procedure, function, or method block.

The component type of a file type cannot be an object type, or any structured type with an object type component.

The scope of a component identifier extends over the domain of its object type. Furthermore, the scope of a component identifier extends over procedure, function, constructor, and destructor blocks that implement methods of the object type and its descendants. For this reason, the spelling of a component identifier must be unique within an object type and all its descendants and all its methods.

The declaration of a method within an object type corresponds to a **forward** declaration of that method. Thus, somewhere after the object type declaration, and within the same scope as the object type declaration, the method must be *implemented* by a defining declaration.

When unique identification of a method is required, a *qualified method identifier* is used. It consists of an object type identifier, followed by a period (.), followed by a method identifier. Like any other identifier, a qualified method identifier can be prefixed with a unit identifier and a period if required.

Within an object type declaration, a method heading can specify parameters of the object type being declared, even though the declaration is not yet complete. This is illustrated by the *Copy*,

*Intersect*, and *Union* methods of the *Rect* type in the previous example.

Methods are by default *static*, but can, with the exception of constructor methods, be made *virtual* through the inclusion of a **virtual** directive in the method declaration. The compiler resolves calls to static methods at compile time, whereas calls to virtual methods are resolved at run time. The latter is sometimes referred to as *late binding*.

If an object type declares or inherits any virtual methods, then variables of that type must be *initialized* through a constructor call before any call to a virtual method. Thus, any object type that declares or inherits any virtual methods must also declare or inherit at least one constructor method.

An object type can *override* (redefine) any of the methods it inherits from its ancestors. If a method declaration in a descendant specifies the same method identifier as a method declaration in an ancestor, then the declaration in the descendant overrides the declaration in the ancestor. The scope of an override method extends over the domain of the descendant in which it is introduced, or until the method identifier is again overridden.

An override of a static method is free to change the method heading in any way it pleases. In contrast, an override of a virtual method must match exactly the order, types, and names of the parameters, and the type of the function result, if any. Furthermore, the override must again include a **virtual** directive.

An object is *instantiated*, or created, through the declaration of a variable or typed constant of an object type, or by applying the *New* standard procedure to a pointer variable of an object type. The resulting object is called an *instance* of the object type.

```
var
  F : Field;
  Z : ZipField;
  FP : FieldPtr;
  ZP : ZipFieldPtr;
```

Given these variable declarations, *F* is an instance of *Field*, and *Z* is an instance of *ZipField*. Likewise, after applying *New* to *FP* and *ZP*, *FP* points to an instance of *Field*, and *ZP* points to an instance of *ZipField*.

A pointer to an object type is assignment compatible with a pointer to any ancestor object type, therefore during execution of

a program, a pointer to an object type might point to an instance of that type, or to an instance of any descendant type.

For example, a pointer of type *ZipFieldPtr* can be assigned to pointers of type *ZipFieldPtr*, *NumFieldPtr*, and *FieldPtr*, and during execution of a program, a pointer of type *FieldPtr* might be either **nil** or point to an instance of *Field*, *StrField*, *NumField*, or *ZipField*, or any other instance of a descendant of *Field*.

These pointer assignment compatibility rules also apply to object type variable parameters. For example, the *Field.Copy* method might be passed an instance of *Field*, *StrField*, *NumField*, *ZipField*, or any other instance of a descendant of *Field*.

A method is activated through a method designator of the form *Instance.Method*, where *Instance* is an instance of an object type, and *Method* is a method of that object type.

For static methods, the *declared* (compile-time) type of *Instance* determines which method to activate. For example, the designators *F.Init* and *FP^.Init* will always activate *Field.Init*, since the declared type of *F* and *FP^* is *Field*.

For virtual methods, the *actual* (run-time) type of *Instance* governs the selection. For example, the designator *FP^.Edit* might activate *Field.Edit*, *StrField.Edit*, *NumField.Edit*, or *ZipField.Edit*, depending on the actual type of the instance pointed to by *FP*.

In general, there is no way of determining which method will be activated by a virtual method designator. You can develop a routine (such as a forms editor input routine) that activates *FP^.Edit*, and later, without modifying that routine, apply it to an instance of a new, unforeseen descendant type of *Field*. When extensibility of this sort is desired, you should employ an object type with an open-ended set of descendant types, rather than a record type with a closed set of variants.

## Assignment compatibility

---

See Chapter 3, "Types," in the Reference Guide.

The rules of assignment compatibility are extended as follows:

- An object type *T2* is assignment compatible with an object type *T1* if *T2* is in the domain of *T1*.

- A pointer type *P2*, pointing to an object type *T2*, is assignment compatible with a pointer type *P1*, pointing to an object type *T1*, if *T2* is in the domain of *T1*.

## Object component designators

---

See Chapter 3, "Types," in the Reference Guide.

The format of an object component designator is the same as that of a record field designator; that is, it consists of an instance (a variable reference), followed by a period and a component identifier. A component designator that designates a method is called a *method designator*. A **with** statement can be applied to an instance of an object type. In that case, the instance and the period can be omitted in referencing components of the object type.

The instance and the period can also be omitted within any method block, and when they are, the effect is the same as if *Self* and a period was written before the component reference.

## Dynamic object type variables

---

See Chapter 3, "Types," in the Reference Guide.

The syntax of the *New* and *Dispose* standard procedures has been extended to allow a constructor or destructor call as a second parameter when object type pointers are allocated and disposed. For further details, see the later section "Extensions to *New* and *Dispose*" on page 88.

## Instance initialization

---

See Chapter 3, "Types," in the Reference Guide.

If an object type contains virtual methods, then instances of that object type must be initialized through a constructor call before any call to a virtual method. Here's an example:

```
var
  S : StrField;
begin
  S.Init(1, 1, 25, 'Firstname');
  S.Put('Frank');
  S.Display;
  ...
  S.Done;
end;
```

If *S.Init* had not been called, then the call to *S.Display* would cause this example to fail.

The rule of required initialization also applies to instances that are components of structured types. For example,

```
var
  Comment : array[1..5] of StrField;
  I : Integer;
begin
  for I := 1 to 5 do Comment[I].Init(1, I + 10, 40, 'Comment');
  ...
  for I := 1 to 5 do Comment[I].Done;
end;
```

For dynamic instances, initialization is typically coupled with allocation, and cleanup is typically coupled with deallocation, using the extended syntax of the *New* and *Dispose* standard procedures. Here's an example:

```
var
  SP : StrFieldPtr;
begin
  New(SP, Init(1, 1, 25, 'Firstname'));
  SP^.Put('Frank');
  SP^.Display;
  ...
  Dispose(SP, Done);
end;
```

## Object type constants

---

See Chapter 5, "Typed Constants," in the *Reference Guide*.

The declaration of an object type constant uses the same syntax as the declaration of a record type constant. No value is, or can be, specified for method components. Referring to the earlier object type declarations, here are some examples of object type constants:

```
const
  ZeroPoint : Point = (X : 0; Y : 0);
  ScreenRect : Rect = (A : (X : 0; Y : 0); B : (X : 80; Y : 25));
  CountField : NumField = (X : 5; Y : 20; Len : 4; Name : nil;
    Value : 0; Min : -999; Max : 999);
```

Constants of an object type that contains virtual methods need *not* be initialized through a constructor call—this initialization is handled automatically by the compiler.



## @ with a method

---

See Chapter 6, "Expressions,"  
in the Reference Guide.

You can apply @ to a qualified method identifier to produce a pointer to the method's entry point.

## Function calls

---

See Chapter 6, "Expressions,"  
in the Reference Guide.

The syntax of a function call has been extended to allow a method designator or a qualified method identifier denoting a function to replace the function identifier.

The discussion of extensions to procedure statements in a later section, "Procedure Statements," also applies to function calls.

## Assignment statements

---

See Chapter 7, "Statements,"  
in the Reference Guide.

The rules of object type assignment compatibility allow an instance of an object type to be assigned an instance of any of its descendant types. Such an assignment constitutes a *projection* of the descendant onto the space spanned by its ancestor. For example, given an instance  $F$  of type *Field*, and an instance  $Z$  of type *ZipField*, the assignment  $F := Z$  will copy only the fields  $X$ ,  $Y$ ,  $Len$ , and  $Name$ .

Assignment to an instance of an object type does *not* entail initialization of the instance. Referring to the preceding example, the assignment  $F := Z$  does not mean that a constructor call for  $F$  can be omitted.

## Procedure statements

---

See Chapter 7, "Statements,"  
in the Reference Guide.

The syntax of a procedure statement has been extended to allow a method designator denoting a procedure, constructor, or destructor to replace the procedure identifier.

The instance denoted by the method designator serves two purposes. First, in the case of a virtual method, the *actual* (run-time) type of the instance determines which implementation of the method is activated. Second, the instance itself becomes an implicit actual parameter of the method; it corresponds to a

formal variable parameter named *Self* that possesses the type corresponding to the activated method.

Within a method, a procedure statement allows a qualified method identifier to denote activation of a specific method. The object type given in the qualified identifier must be the same as the method's object type, or an ancestor of it. This type of activation is called a *qualified activation*.

The implicit *Self* parameter of a qualified activation becomes the *Self* of the method containing the call. A qualified activation never employs the virtual method dispatch mechanism—the call is always static and always invokes the specified method.

A qualified activation is generally used within an override method to activate the overridden method. Referring to the types declared earlier, here are some examples of qualified activations:

```
constructor NumField.Init(FX, FY, FLen : Integer;
    FName : String; FMin, FMax : Longint);
begin
    Field.Init(FX, FY, FLen, FName);
    Value := 0;
    Min := FMin;
    Max := FMax;
end;

function ZipField.PutStr(S : String) : Boolean;
begin
    PutStr := (Length(S) = 5) and NumField.PutStr(S);
end;
```

As these examples demonstrate, a qualified activation allows an override method to “reuse” the code of the method it overrides.

## Case statements

---

*See Chapter 7, “Statements,” in the Reference Guide.*

The **case** statement previously did not allow the selector to be of type `Word`. This restriction is now gone, and a case selector may be of any byte-sized or word-sized ordinal type.

## With statements

---

*See Chapter 7, “Statements,” in the Reference Guide.*

The **with** statement has been extended to accept object types as well as record types.

## Method declarations

---

See Chapter 8, "Procedures and Functions," in the Reference Guide.

The declaration of a method within an object type corresponds to a **forward** declaration of that method. Thus, somewhere after the object type declaration and within the same scope as the object type declaration, the method must be *implemented* by a defining declaration.

For procedure and function methods, the defining declaration takes the form of a normal procedure or function declaration, with the exception that the procedure or function identifier in this case is a qualified method identifier.

For constructor methods and destructor methods, the defining declaration takes the form of a procedure method declaration, except that the **procedure** reserved word is replaced by a **constructor** or **destructor** reserved word.

A method's defining declaration can optionally repeat the formal parameter list of the method heading in the object type. The defining declaration's method heading must in that case match exactly the order, types, and names of the parameters, and the type of the function result, if any.

In the defining declaration of a method, there is always an implicit parameter with the identifier *Self*, corresponding to a formal variable parameter that possesses the object type. Within the method block, *Self* represents the instance whose method component was designated to activate the method. Thus, any changes made to the values of the fields of *Self* are reflected in the instance.

The scope of a component identifier in an object type extends over any procedure, function, constructor, or destructor block that implements a method of the object type. The effect is the same as if the entire method block was embedded in a **with** statement of the form

```
with Self do begin ... end
```

For this reason, the spellings of component identifiers, formal method parameters, *Self*, and any identifiers introduced in a method implementation must be unique.

Here are some examples of method implementations:

```

procedure Rect.Intersect(var R : Rect);
begin
  if A.X < R.A.X then A.X := R.A.X;
  if A.Y < R.A.Y then A.Y := R.A.Y;
  if B.X > R.B.X then B.X := R.B.X;
  if B.Y > R.B.Y then B.Y := R.B.Y;
  if (A.X >= B.X) or (A.Y >= B.Y) then Init(0, 0, 0, 0);
end;

procedure Field.Display;
begin
  GotoXY(X, Y);
  Write(Name^, ' ', GetStr);
end;

function NumField.PutStr(S : String) : Boolean;
var
  E : Integer;
begin
  Val(S, Value, E);
  PutStr := (E = 0) and (Value >= Min) and (Value <= Max);
end;

```

## Constructors and destructors

---

*See Chapter 8, "Procedures and Functions," in the Reference Guide.*

Constructors and destructors are specialized forms of methods. Used in connection with the extended syntax of the *New* and *Dispose* standard procedures, constructors and destructors have the ability to allocate and deallocate dynamic objects. In addition, constructors have the ability to perform the required initialization of objects that contain virtual methods. Like other methods, constructors and destructors can be inherited, and an object can have any number of constructors and destructors.

Constructors are used to initialize newly instantiated objects. Typically, the initialization is based on values passed as parameters to the constructor. Constructors cannot be virtual, because the virtual method dispatch mechanism depends on a constructor first having initialized the object.

Here are some examples of constructors:

```

constructor Field.Copy(var F : Field);
begin
    Self := F;
end;

constructor Field.Init(FX, FY, FLen : Integer; FName : String);
begin
    X := FX;
    Y := FY;
    Len := FLen;
    GetMem(Name, Length(FName) + 1);
    Name^ := FName;
end;

constructor StrField.Init(FX, FY, FLen : Integer; FName : String);
begin
    Field.Init(FX, FY, FLen, FName);
    GetMem(Value, Len);
    Value^ := '';
end;

```

The first action of a constructor of a descendant type, such as the preceding *StrField.Init*, is almost always to call its immediate ancestor's corresponding constructor to initialize the inherited fields of the object. Having done that, the constructor then initializes the fields of the object that were introduced in the descendant.

*Destructors can be virtual, and often are. Destructors seldom take any parameters.*

Destructors are the counterparts of constructors, and are used to clean up objects after their use. Typically, the cleanup consists of disposing any pointer fields in the object.

Here are some examples of destructors:

```

destructor Field.Done;
begin
    FreeMem(Name, Length(Name^) + 1);
end;

destructor StrField.Done;
begin
    FreeMem(Value, Len);
    Field.Done;
end;

```

A destructor of a descendant type, such as the preceding *StrField.Done*, typically first disposes the pointer fields introduced in the descendant, and then, as its last action, calls the corresponding destructor of its immediate ancestor to dispose any inherited pointer fields of the object.

## Variable parameters

---

See Chapter 8, "Procedures and Functions," in the Reference Guide.

The rules of object type assignment compatibility also apply to object type variable parameters: For a formal parameter of type *T1*, the actual parameter might be of type *T2* if *T2* is in the domain of *T1*. For example, the *Field.Copy* method might be passed an instance of *Field*, *StrField*, *NumField*, *ZipField*, or any other instance of a descendant of *Field*.

## Extensions to New and Dispose

---

See Chapter 11, "Standard Procedures and Functions," in the Reference Guide.

The *New* and *Dispose* standard procedures have been extended to allow a constructor call or destructor call as a second parameter for allocating or disposing a dynamic object type variable. The syntax is

```
New(P, Construct)
```

and

```
Dispose(P, Destruct)
```

where *P* is a pointer variable, pointing to an object type, and *Construct* and *Destruct* are calls to constructors and destructors of that object type. For *New*, the effect of the extended syntax is the same as executing

```
New(P);  
P^.Construct;
```

And for *Dispose*, the effect of the extended syntax is the same as executing

```
P^.Destruct;  
Dispose(P);
```

Without the extended syntax, occurrences of such "pairs" of a call to *New* followed by a constructor call, and a destructor call followed by a call to *Dispose* would be very common. The extended syntax improves readability, and also generates shorter and more efficient code.

The following illustrates the use of the extended *New* and *Dispose* syntax:

```

var
  SP : StrFieldPtr;
  ZP : ZipFieldPtr;
begin
  New(SP, Init(1, 1, 25, 'Firstname'));
  New(ZP, Init(1, 2, 5, 'Zip code', 0, 99999));
  SP^.Edit;
  ZP^.Edit;
  ...
  Dispose(ZP, Done);
  Dispose(SP, Done);
end;

```

An additional extension allows *New* to be used as a *function*, which allocates and returns a dynamic variable of a specified type. The syntax is

```
New(T)
```

or

```
New(T, Construct)
```

In the first form, *T* can be any pointer type. In the second form, *T* must point to an object type, and *Construct* must be a call to a constructor of that object type. In both cases, the type of the function result is *T*.

Here's an example:

```

var
  F1, F2 : FieldPtr;
begin
  F1 := New(StrFieldPtr, Init(1, 1, 25, 'Firstname'));
  F2 := New(ZipFieldPtr, Init(1, 2, 5, 'Zip code', 0, 99999));
  ...
  WriteLn(F1^.GetStr);      { calls StrField.GetStr }
  WriteLn(F2^.GetStr);     { calls ZipField.GetStr }
  ...
  Dispose(F2, Done);       { calls Field.Done }
  Dispose(F1, Done);       { calls StrField.Done }
end;

```

Notice that even though *F1* and *F2* are of type *FieldPtr*, the extended pointer assignment compatibility rules allow *F1* and *F2* to be assigned a pointer to any descendant of *Field*; and since *GetStr* and *Done* are virtual methods, the virtual method dispatch mechanism correctly calls *StrField.GetStr*, *ZipField.GetStr*, *Field.Done*, and *StrField.Done*, respectively.

## Compiler directive conditional symbols

---

*See Appendix B, "Compiler Directives," in the Reference Guide.*

The VER50 conditional symbol, which is automatically defined by Turbo Pascal 5.0, has been replaced by VER55 in Turbo Pascal 5.5.



## Overlays

This chapter describes the new features found in Turbo Pascal 5.5's overlay manager. The new *Overlay* unit is fully compatible with Turbo Pascal 5.0's *Overlay* unit, so any existing overlaid applications can simply be recompiled.

### Overlay buffer management

---

The Turbo Pascal 5.0 overlay buffer is best described as a ring buffer that has a head pointer and a tail pointer. Overlays are always loaded at the head of the buffer, pushing "older" ones toward the tail. When the buffer becomes full (that is, when there is not enough free space between the head and the tail), overlays are disposed at the tail to make room for new ones.

Since ordinary memory is not circular in nature, the actual implementation of the overlay buffer involves a few more steps in order to make the buffer appear to be a ring. Figure 4 illustrates the process. The figure shows a progression of overlays being loaded into an initially empty overlay buffer. Overlay *A* is loaded first, followed by *B*, then *C*, and finally *D*. Shaded areas indicate free buffer space.

Figure 4.1  
Loading and disposing  
overlays

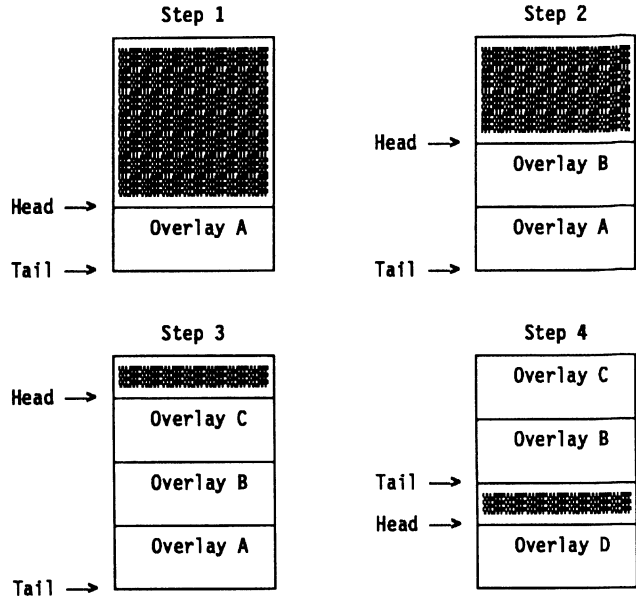

As you can see, a couple of interesting things happen in the transition from step 3 to step 4. First, the head pointer wraps around to the bottom of the overlay buffer, causing the overlay manager to slide all loaded overlays (and the tail pointer) upward. This sliding is required to always keep the free area located between the head pointer and the tail pointer. Second, in order to load overlay *D*, the overlay manager has to dispose overlay *A* from the tail of the buffer. Overlay *A* in this case is the least recently loaded overlay, and therefore the best choice for disposal when something has to go. The overlay manager continues to dispose overlays at the tail to make room for new ones at the head, and each time the head pointer wraps around, the sliding operation is repeated.

This is how Turbo Pascal 5.0's overlay manager operates, and is also the default mode of operation for Turbo Pascal 5.5's overlay manager. New in Turbo Pascal 5.5, however, is an optional optimization of the overlay management algorithm.

Imagine that overlay *A* contains a number of frequently used routines. Even though these routines are used all the time, *A* will still occasionally be thrown out of the overlay buffer, only to be reloaded again shortly thereafter. The problem here is that the overlay manager knows nothing about the *frequency* of calls to

routines in *A*—all it knows is that when a call is made to a routine in *A* and *A* is not in memory, it has to load *A*. One solution to this problem might be to trap every call to routines in *A*, and then at each call move *A* to the head of the overlay buffer to reflect its new status as the most recently used overlay. Such call interception is unfortunately very costly in terms of execution speed, and may in some cases slow down the application even more than the additional overlay load operations.

Turbo Pascal 5.5 provides a compromise solution that incurs practically no performance overhead and still maintains a high degree of success in identifying frequently used overlays that shouldn't be unloaded: When an overlay gets close to the tail of the overlay buffer, it is put on "probation." If, during this probationary period, a call is made to a routine in the overlay, it is "reprieved," and will not be disposed when it reaches the tail of the overlay buffer. Instead, it is simply moved to the head of the buffer, and thus gets another free ride around the overlay buffer ring. If, on the other hand, no calls are made to an overlay during its probationary period, indicating less frequent use, the overlay is disposed of when it reaches the tail of the overlay buffer.

The net effect of the probation/reprieve scheme is that frequently used overlays are kept in the overlay buffer, at the cost of intercepting just *one* call every time the overlay gets close to the tail of the overlay buffer.

Two new overlay manager routines, *OvrSetRetry* and *OvrGetRetry*, control the probation/reprieve mechanism. *OvrSetRetry* sets the size of the area in the overlay buffer to keep on probation, and *OvrGetRetry* returns the current setting. If an overlay falls within the last *OvrGetRetry* bytes before the overlay buffer tail, it is automatically put on probation. Any free space in the overlay buffer is considered part of the probation area.

# Variables

---

This section describes the new variables that Turbo Pascal 5.5 adds to the *Overlay* unit.

---

## OvrTrapCount

```
var OvrTrapCount : Word;
```

Each time a call to an overlaid routine is intercepted by the overlay manager, either because the overlay is not in memory or because the overlay is on probation, the *OvrTrapCount* variable is incremented. The initial value of *OvrTrapCount* is 0.

---

## OvrLoadCount

```
var OvrLoadCount : Word;
```

Each time an overlay is loaded, the *OvrLoadCount* variable is incremented. The initial value of *OvrLoadCount* is zero.

By examining *OvrTrapCount* and *OvrLoadCount* (for example, in the debugger's Watch window) over identical runs of an application, you can monitor the effect of different probation area sizes (set with *OvrSetRetry*) to find the optimal size for your particular application.

---

## OvrFileMode

```
var OvrFileMode : Byte;
```

The *OvrFileMode* variable determines the access code to pass to DOS when the overlay file is opened. The default *OvrFileMode* is 0, corresponding to read-only access. By assigning a new value to *OvrFileMode* before calling *OvrInit*, you can change the access code, for example, to allow shared access on a network system. For further details on access code values, refer to your *DOS Programmer's Reference Manual*.

---

## OvrReadBuf

```
type OvrReadFunc = function (OvrSeg : Word) : Integer;  
var OvrReadBuf : OvrReadFunc;
```

The *OvrReadBuf* procedure variable allows you to intercept overlay load operations, for example, to implement error handling or

to check that a removable disk is present. Whenever the overlay manager needs to read an overlay, it calls the function whose address is stored in *OvrReadBuf*. If the function returns zero, the overlay manager assumes that the operation was successful; if the function result is nonzero, run-time error 209 is generated. The *OvrSeg* parameter indicates what overlay to load, but as you'll see later, you never need to access this information.

*You must never attempt to call any overlaid routines from within your overlay read function—such calls would crash the system.*

To install your own overlay read function, you must first save the previous value of *OvrReadBuf* in a variable of type *OvrReadFunc*, and then assign your overlay read function to *OvrReadBuf*. Within your read function, you should call the saved read function to perform the actual load operation. Any validations you want to perform, such as checking that a removable disk is present, should go before the call to the saved read function, and any error checking should go after the call.

The code to install an overlay read function should go right after the call to *OvrInit*; at this point, *OvrReadBuf* will contain the address of the default disk read function.

If you also call *OvrInitEMS*, it uses your read function to read overlays from disk into EMS memory, and if no errors occur, it stores the address of the default EMS read function in *OvrReadBuf*. If you also wish to override the EMS read function, simply repeat the installation process after the call to *OvrInitEMS*.

The default disk read function returns zero in case of success, or a DOS error code in case of failure. Likewise, the default EMS read function returns 0 in case of success, or an EMS error code (ranging from \$80 through \$FF) in case of failure. For details on DOS error codes, refer to the "Run-time Errors" section in Appendix D of the *Turbo Pascal Reference Guide*. For details on EMS error codes, refer to the *Lotus/Intel/Microsoft Expanded Memory Specification*.

The following code fragment demonstrates how to write and install an overlay read function. The new overlay read function repeatedly calls the saved overlay read function until no errors occur. Any errors are passed to the *DOSError* or *EMSError* procedures (not shown here) so that they can present the error to the user. Notice how the *OvrSeg* parameter is just passed on to the saved overlay read function and never directly handled by the new overlay read function.

```

uses Overlay;
var
  SaveOvrRead : OvrReadFunc;
  UsingEMS : Boolean;

{$F+}

function MyOvrRead(OvrSeg : Word) : Integer;
var
  E : Integer;
begin
  repeat
    E := SaveOvrRead(OvrSeg);
    if E <> 0 then
      if UsingEMS then
        EMSError(E) else DOSError(E);
    until E = 0;
  MyOvrRead := 0;
end;

{$F-}

begin
  OvrInit('MYPROG.OVR');
  SaveOvrRead := OvrReadBuf; { Save disk default }
  OvrReadBuf := MyOvrRead; { Install ours }
  UsingEMS := False;
  OvrInitEMS;
  if (OvrResult = OvrOK) then

  begin
    SaveOvrRead := OvrReadBuf; { Save EMS default }
    OvrReadBuf := MyOvrRead; { Install ours }
    UsingEMS := True;
  end;
  ...
end.

```

## Procedures and functions

---

This section describes the new procedures and functions that Turbo Pascal 5.5 adds to the *Overlay* unit.

## OvrSetRetry

---

```
procedure OvrSetRetry(Size : Longint);
```

The *OvrSetRetry* procedure sets the size of the “probation area” in the overlay buffer. If an overlay falls within the *Size* bytes before the overlay buffer tail, it is automatically put on probation. Any free space in the overlay buffer is considered part of the probation area. For reasons of compatibility with earlier versions of the overlay manager, the default probation area size is zero, which effectively disables the probation/reprieve mechanism. Here’s an example of how to use *OvrSetRetry*:

```
OvrInit('MYPROG.OVR');  
OvrSetBuf(BufferSize);  
OvrSetRetry(BufferSize div 3);
```

There is no empirical formula for determining the optimal size of the probationary area—however, experiments have shown that values ranging from one-third to one-half of the overlay buffer size provide the best results.

## OvrGetRetry

---

```
function OvrGetRetry : Longint;
```

The *OvrGetRetry* function returns the current size of the probation area, that is, the value last set with *OvrSetRetry*.

## Overlays in .EXE files

---

Turbo Pascal 5.5 allows you to store your overlays at the end of your application’s .EXE file rather than in a separate .OVR file. To attach an .OVR file to the end of an .EXE file, use the DOS COPY command with a /B command line switch, for example,

```
COPY/B MYPROG.EXE + MYPROG.OVR
```

You must make sure that the .EXE file was compiled *without* Turbo Debugger debug information. Thus in the IDE, make sure that Debug/Standalone Debugging is set to *Off*; with the command-line version of the compiler, make sure not to specify a /V switch.

To read overlays from the end of an .EXE file instead of from a separate .OVR file, simply specify the .EXE file name in the call to *OvrInit*. If you are running under DOS 3.x, you can use the *ParamStr* standard function to obtain the name of the .EXE file, for example,

```
OvrInit (ParamStr (0));
```



## *Inside Turbo Pascal*

This chapter is an addendum to Chapter 15, "Inside Turbo Pascal," in the *Turbo Pascal 5.0 Reference Guide*.

### Internal data format of objects

---

The internal data format of an object resembles that of a record. The fields of an object are stored in order of declaration, as a contiguous sequence of variables. Any fields inherited from an ancestor type are stored before the new fields defined in the descendant type.

If an object type defines virtual methods, constructors, or destructors, the compiler allocates an extra field in the object type. This 16-bit field, called the *virtual method table (VMT) field*, is used to store the offset of the object type's VMT in the data segment. The VMT field immediately follows after the ordinary fields in the object type. When an object type inherits virtual methods, constructors, or destructors, it also inherits a VMT field, so an additional one is not allocated.

Initialization of the VMT field of an instance is handled by the object type's constructor(s). A program never explicitly initializes or accesses the VMT field.

The following examples illustrate the internal data formats of object types.

```

type
  LocationPtr = ^Location;
  Location = object
    X, Y: Integer;
    procedure Init(PX, PY: Integer);
    function GetX: Integer;
    function GetY: Integer;
  end;

  PointPtr = ^Point;
  Point = object(Location)
    Color: Integer;
    constructor Init(PX, PY, PColor: Integer);
    destructor Done; virtual;
    procedure Show; virtual;
    procedure Hide; virtual;
    procedure MoveTo(PX, PY: Integer); virtual;
  end;

  CirclePtr = ^Circle;
  Circle = object(Point)
    Radius: Integer;
    constructor Init(PX, PY, PColor, PRadius: Integer);
    procedure Show; virtual;
    procedure Hide; virtual;
    procedure Fill; virtual;
  end;

```

Figure 5.1 shows layouts of instances of *Location*, *Point*, and *Circle*; each box corresponds to one word of storage.

Figure 5.1  
Layouts of instances of  
*Location*, *Point*, and *Circle*

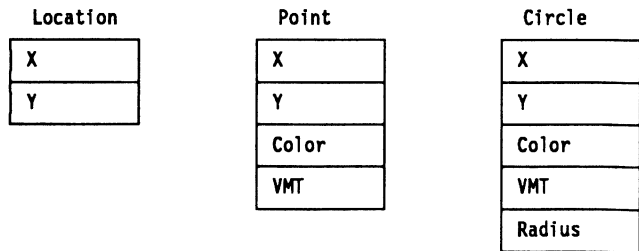

Because *Point* is the first type in the hierarchy that introduces virtual methods, the VMT field is allocated right after the *Color* field.

---

## Virtual method tables

Each object type that contains or inherits virtual methods, constructors, or destructors has a VMT associated with it, which is

stored in the initialized part of the program's data segment. There is only one VMT per object type (not one per instance), but two distinct object types never share a VMT, no matter how identical they appear to be. VMTs are built automatically by the compiler, and are never directly manipulated by a program. Likewise, pointers to VMTs are automatically stored in object type instances by the object type's constructor(s) and are never directly manipulated by a program.

The first word of a VMT contains the size of instances of the associated object type; this information is used by constructors and destructors to determine how many bytes to allocate or dispose of, using the extended syntax of the *New* and *Dispose* standard procedures.

The second word of a VMT contains the negative size of instances of the associated object type; this information is used by the virtual method call validation mechanism to detect uninitialized objects (instances for which no constructor call has been made), and to check the consistency of the VMT. When virtual call validation is enabled (using the `{R+}` compiler directive, which has been expanded to include virtual method checking), the compiler generates a call to a VMT validation routine before each virtual call. The VMT validation routine checks that the first word of the VMT is not zero, and that the sum of the first and the second word is zero. If either check fails, run-time error 210 is generated.



Enabling range-checking and virtual method call checking slows down your program and makes it somewhat larger, so use the `{R+}` state only when debugging, and switch to the `{R-}` state for the final version of the program.

Finally, starting at offset 4 in the VMT, comes a list of 32-bit method pointers, one per virtual method in the object type, in order of declaration. Each slot contains the address of the corresponding virtual method's entry point.

Figure 5.2 shows the layouts of the VMTs of the *Point* and *Circle* types (the *Location* type has no VMT, since it contains no virtual methods, constructors, or destructors); each small box corresponds to one word of storage, and each large box corresponds to two words of storage.

Figure 5.2  
Point and Circle's VMT  
layouts

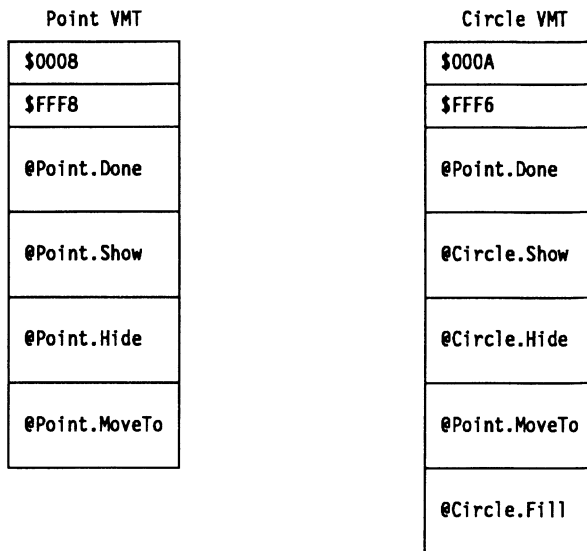

Notice how *Circle* inherits the *Done* and *MoveTo* methods from *Point*, and how it overrides the *Show* and *Hide* methods.

As mentioned already, an object type's constructors contain special code that stores the offset of the object type's VMT in the instance being initialized. For example, given an instance *P* of type *Point*, and an instance *C* of type *Circle*, a call to *P.Init* will automatically store the offset of *Point*'s VMT in *P*'s VMT field, and a call to *C.Init* will likewise store the offset of *Circle*'s VMT in *C*'s VMT field. This automatic initialization is part of a constructor's entry code, so when control arrives at the **begin** of the constructor's statement part, the VMT field *Self* will already have been set up. Thus, if the need arises, a constructor can make calls to virtual methods.

---

## The SizeOf standard function

When applied to an instance of an object type that has a VMT, *SizeOf* returns the size stored in the VMT. Thus, for object types that have a VMT, *SizeOf* always returns the *actual* size of the instance, rather than the *declared* size.

## The TypeOf standard function

---

Turbo Pascal 5.5 adds a new standard function, *TypeOf*, which returns a pointer to an object type's VMT. *TypeOf* takes a single parameter, which can be either an object type identifier or an object type instance. In both cases, the result, which is of type *Pointer*, is a pointer to the object type's VMT. *TypeOf* can be applied only to object types that have a VMT—all other types result in an error.

The *TypeOf* function can be used to test the actual type of an instance. For example,

```
if TypeOf(Self) = TypeOf(Point) then ...
```

## Virtual method calls

---

To call a virtual method, the compiler generates code that picks up the VMT address from the VMT field in the object, and then calls via the slot associated with the method. For example, given a variable *PP* of type *PointPtr*, the call *PP^.Show* generates the following code:

```
les    di,PP           ;Load PP into ES:DI
push   es             ;Pass as Self parameter
push   di
mov    di,es:[di+6]   ;Pick up VMT offset from VMT field
call   DWORD PTR [di+8] ;Call VMT entry for Show
```

The type compatibility rules of object types allow *PP* to point at a *Point* or a *Circle*, or at any other descendant of *Point*. And if you examine the VMTs shown here, you'll see that for a *Point*, the entry at offset 8 in the VMT points to *Point.Show*; whereas for a *Circle*, it points to *Circle.Show*. Thus, depending upon the *actual* run-time type of *PP*, the **CALL** instruction calls *Point.Show* or *Circle.Show*, or the *Show* method of any other descendant of *Point*.

If *Show* had been a static method, this code would have been generated for the call to *PP^.Show*:

```
les    di,PP           ;Load PP into ES:DI
push   es             ;Pass as Self parameter
push   di
call   Point.Show     ;Directly call Point.Show
```

Here, no matter what *PP* points to, the code will always call the *Point.Show* method.

## Method calling conventions

---

Methods use the same calling conventions as ordinary procedures and functions, except that every method has an additional implicit parameter, called *Self*, that corresponds to a **var** parameter of the same type as the method's object type. The *Self* parameter is always passed as the last parameter, and always takes the form of a 32-bit pointer to the instance through which the method is called. For example, given a variable *PP* of type *PointPtr* as defined earlier, the call *PP^.MoveTo(10, 20)* is coded as follows:

```
mov    ax,10                ;Load 10 into AX
push  ax                    ;Pass as PX parameter
mov    ax,20                ;Load 20 into AX
push  ax                    ;Pass as PY parameter
les   di,PP                 ;Load PP into ES:DI
push  es                    ;Pass as Self parameter
push  di
mov   di,es:[di+6]         ;Pick up VMT offset from VMT field
call  DWORD PTR [di+16]   ;Call VMT entry for MoveTo
```

Upon returning, a method must remove the *Self* parameter from the stack, just as it must remove any normal parameters.

Methods always use the **FAR CALL** model, regardless of the setting of the **\$F** compiler directive.

---

## Constructors and destructors

Constructors and destructors use the same calling conventions as normal methods, except that an additional word-sized parameter, called the *VMT* parameter, is passed on the stack just before the *Self* parameter.

For constructors, the *VMT* parameter contains the *VMT* offset to store in *Self*'s *VMT* field in order to initialize *Self*.

Furthermore, when a constructor is called to allocate a dynamic object, using the extended syntax of the *New* standard procedure, a **nil** pointer is passed in the *Self* parameter. This causes the constructor to allocate a new dynamic object, the address of which is passed back to the caller in **DX:AX** when the constructor returns. If the constructor could not allocate the object, a **nil** pointer is returned in **DX:AX**. (See "Constructor error recovery" on page 108.)

Finally, when a constructor is called using a qualified method identifier (that is, an object type identifier), followed by a period and a method identifier, a value of zero is passed in the VMT parameter. This indicates to the constructor that it should *not* initialize the VMT field of *Self*.

For destructors, a 0 in the VMT parameter indicates a normal call, and a nonzero value indicates that the destructor was called using the extended syntax of the *Dispose* standard procedure. This causes the destructor to deallocate *Self* just before returning (the size of *Self* is found by looking at the first word of *Self*'s VMT).

## Assembly language methods

---

Method implementations written in assembly language can be linked with Turbo Pascal programs using the `$L` compiler directive and the `external` reserved word. The declaration of an external method in an object type is no different than that of a normal method; however, the implementation of the method lists only the method header followed by the reserved word `external`.

In an assembly language source text, an `@` is used instead of a period (`.`) to write qualified identifiers (the period already has a different meaning in assembly language and cannot be part of an identifier). For example, the Pascal identifier `Rect.Init` is written as `Rect@Init` in assembly language. The `@` syntax can be used to declare both `PUBLIC` and `EXTRN` identifiers.

As an example of assembly language methods, we've implemented a simple *Rect* object.

```
type
  Rect = object
    X1, Y1, X2, Y2: Integer;
    procedure Init(XA, YA, XB, YB: Integer);
    procedure Union(var R: Rect);
    function Contains(X, Y: Integer): Boolean;
  end;
```

A *Rect* represents a rectangle bounded by four coordinates, *X1*, *Y1*, *X2*, and *Y2*. The upper left corner of a rectangle is defined by *X1* and *Y1*, and the lower right corner is defined by *X2* and *Y2*. The *Init* method assigns values to the rectangle's coordinates; the *Union* method calculates the smallest rectangle that contains both the rectangle itself and another rectangle; and the *Contains*

method returns *True* if a given point is within the rectangle, or *False* if not. Other methods, such as moving, resizing, calculating intersections, and testing for equality, could easily be implemented to make *Rect* a more useful object.

The Pascal implementations of *Rect*'s methods list only the method header followed by an **external** reserved word.

```
{ $L RECT }

procedure Rect.Init(XA, YA, XB, YB: Integer); external;
procedure Rect.Union(var R: Rect); external;
function Rect.Contains(X, Y: Integer): Boolean; external;
```

There is, of course, no requirement that all methods be implemented as externals. Each individual method can be implemented in either Pascal or in assembly language, as desired.

The assembly language source file, RECT.ASM, that implements the three external methods is listed here.

```
                TITLE   Rect
                LOCALS  @@

; Rect structure

Rect   STRUC
X1     DW      ?
Y1     DW      ?
X2     DW      ?
Y2     DW      ?
Rect   ENDS

Code   SEGMENT BYTE PUBLIC

                ASSUME  cs:code

; procedure Rect.Init(XA, YA, XB, YB: Integer)

                PUBLIC  Rect@Init

Rect@Init     PROC   FAR

@XA          EQU    (WORD PTR [bp+16])
@YA          EQU    (WORD PTR [bp+14])
@XB          EQU    (WORD PTR [bp+12])
@YB          EQU    (WORD PTR [bp+10])
@Self        EQU    (DWORD PTR [bp+6])

                push   bp                ;Save bp
                mov    bp,sp            ;Set up stack frame
                les    di,@Self        ;Load Self into ES:DI
                cld                    ;Move forwards
                mov    ax,@XA          ;X1 := XA
```



```

        stosw
        mov     ax,@YA           ;Y1 := YA
        stosw
        mov     ax,@XB           ;X2 := XB
        stosw
        mov     ax,@YB           ;Y2 := YB
        stosw
        pop     bp               ;Restore BP
        ret     12               ;Pop parameters and return

Rect@Init      ENDP

; procedure Rect.Union(var R: Rect)
        PUBLIC Rect@Union
Rect@Union     PROC     FAR
@R             EQU     (DWORD PTR [bp+10])
@Self         EQU     (DWORD PTR [bp+6])
        push   bp               ;Save BP
        mov    bp,sp           ;Set up stack frame
        push   ds               ;Save DS
        lds   si,@R            ;Load R into DS:SI
        les   di,@Self         ;Load Self into ES:DI
        cld                       ;Move forward
        lodsw                ;If R.X1 >= X1 goto @@1
        scasw
        jge   @@1
        dec   di               ;X1 := R.X1
        dec   di
        stosw
@@1:          lodsw                ;If R.Y1 >= Y1 goto @@2
        scasw
        jge   @@2
        dec   di               ;Y1 := R.Y1
        dec   di
        stosw
@@2:          lodsw                ;If R.X2 <= X2 goto @@3
        scasw
        jle   @@3
        dec   di               ;X2 := R.X2
        dec   di
        stosw
@@3:          lodsw                ;If R.Y2 <= Y2 goto @@4
        scasw
        jle   @@4
        dec   di               ;Y2 := R.Y2
        dec   di
        stosw
@@4:          pop    ds           ;Restore DS

```

```

        pop    bp            ;Restore BP
        ret    8            ;Pop parameters and return

Rect@Union    ENDP

; function Rect.Contains(X, Y: Integer): Boolean

        PUBLIC Rect@Contains

Rect@Contains    PROC    FAR

@X            EQU    (WORD PTR [bp+12])
@Y            EQU    (WORD PTR [bp+10])
@Self        EQU    (DWORD PTR [bp+6])

        push  bp            ;Save BP
        mov   bp,sp        ;Set up stack frame
        les  di,@Self     ;Load Self into ES:DI
        mov  al,0         ;Return false
        mov  dx,@X        ;If (X < X1) or (X > X2) goto @@1
        cmp  dx,es:[di].X1
        jl   @@1
        cmp  dx,es:[di].X2
        jg   @@1
        mov  dx,@Y        ;If (Y < Y1) or (Y > Y2) goto @@2
        cmp  dx,es:[di].Y1
        jl   @@1
        cmp  dx,es:[di].Y2
        jg   @@1
        inc  ax            ;Return true
@@1:    pop   bp            ;Restore BP
        ret   8            ;Pop parameters and return

Rect@Contains    ENDP

Code    ENDS

        END

```

## Constructor error recovery

---

As described in Chapter 15 of the *Reference Guide*, Turbo Pascal allows you to install a heap error function through the *HeapError* variable in the *System* unit. This functionality is still supported in Turbo Pascal 5.5, but now it also affects the way object type constructors work.

By default, when there is not enough memory to allocate a dynamic instance of an object type, a constructor call using the extended syntax of the *New* standard procedure generates run-

time error 203. If you install a heap error function that returns 1 rather than the standard function result of 0, a constructor call through *New* will return *nil* when it cannot complete the request (instead of aborting the program).

The code that performs allocation and VMT field initialization of a dynamic instance is part of a constructor's entry sequence: When control arrives at the **begin** of the constructor's statement part, the instance will already have been allocated and initialized. If allocation fails, and if the heap error function returns 1, the constructor skips execution of the statement part and returns a *nil* pointer; thus, the pointer specified in the *New* construct that called the constructor is set to *nil*.

*There's a new standard procedure called Fail.*

Once control arrives at the **begin** of a constructor's statement part, the object type instance is guaranteed to have been allocated and initialized successfully. However, the constructor itself might attempt to allocate dynamic variables, in order to initialize pointer fields in the instance, and these allocations might in turn fail. If that happens, a well-behaved constructor should reverse any successful allocations, and finally deallocate the object type instance so that the net result becomes a *nil* pointer. To make such "backing out" possible, Turbo Pascal implements a new standard procedure called *Fail*, which takes no parameters and can be called only from within a constructor. A call to *Fail* causes a constructor to deallocate the dynamic instance that was allocated upon entry to the constructor, and causes the return of a *nil* pointer to indicate its failure.

When dynamic instances are allocated through the extended syntax of *New*, a resulting value of *nil* in the specified pointer variable indicates that the operation failed. Unfortunately, there is no such pointer variable to inspect after the construction of a static instance or when an inherited constructor is called. Instead, Turbo Pascal allows a constructor to be used as a Boolean function in an expression: A return value of *True* indicates success, and a return value of *False* indicates failure due to a call to *Fail* within the constructor.

The following program implements two simple object types that contain pointers. This first version of the program does not implement constructor error recovery.

```

type
  LinePtr = ^Line;
  Line = string[79];

  BasePtr = ^Base;
  Base = object
    L1, L2: LinePtr;
    constructor Init(S1, S2: Line);
    destructor Done; virtual;
    procedure Dump; virtual;
  end;

  DerivedPtr = ^Derived;
  Derived = object(Base)
    L3, L4: LinePtr;
    constructor Init(S1, S2, S3, S4: Line);
    destructor Done; virtual;
    procedure Dump; virtual;
  end;

var
  BP: BasePtr;
  DP: DerivedPtr;

constructor Base.Init(S1, S2: Line);
begin
  New(L1);
  New(L2);
  L1^ := S1;
  L2^ := S2;
end;

destructor Base.Done;
begin
  Dispose(L2);
  Dispose(L1);
end;

procedure Base.Dump;
begin
  WriteLn('B: ', L1^, ', ', L2^, '.');
end;

constructor Derived.Init(S1, S2, S3, S4: Line);
begin
  Base.Init(S1, S2);
  New(L3);
  New(L4);
  L3^ := S3;
  L4^ := S4;
end;

```

```

destructor Derived.Done;
begin
  Dispose(L4);
  Dispose(L3);
  Base.Done;
end;

procedure Derived.Dump;
begin
  WriteLn('D: ', L1^, ', ', L2^, ', ', L3^, ', ', L4^, '.');
end;

begin
  New(BP, Init('Turbo', 'Pascal'));
  New(DP, Init('North', 'East', 'South', 'West'));
  BP^.Dump;
  DP^.Dump;
  Dispose(DP, Done);
  Dispose(BP, Done);
end.

```

The next example demonstrates how the previous one can be rewritten to implement error recovery. The type and variable declarations are not repeated, because they remain the same.

```

constructor Base.Init(S1, S2: Line);
begin
  New(L1);
  New(L2);
  if (L1 = nil) or (L2 = nil) then

    begin
      Base.Done;
      Fail;
    end;
  L1^ := S1;
  L2^ := S2;
end;

destructor Base.Done;
begin
  if L2 <> nil then Dispose(L2);
  if L1 <> nil then Dispose(L1);
end;

constructor Derived.Init(S1, S2, S3, S4: Line);
begin
  if not Base.Init(S1, S2) then Fail;
  New(L3);
  New(L4);
  if (L3 = nil) or (L4 = nil) then

```

```

begin
    Derived.Done;
    Fail;
end;
L3^ := S3;
L4^ := S4;
end;

destructor Derived.Done;
begin
    if L4 <> nil then Dispose(L4);
    if L3 <> nil then Dispose(L3);
    Base.Done;
end;

{$F+}
function HeapFunc(Size: Word): Integer;
begin
    HeapFunc := 1;
end;
{$F-}

begin
    HeapError := @HeapFunc;    { Install heap error handler }
    New(BP, Init('Turbo', 'Pascal'));
    New(DP, Init('North', 'East', 'South', 'West'));
    if (BP = nil) or (DP = nil) then
        WriteLn('Allocation error')
    else
        begin
            BP^.Dump;
            DP^.Dump;
        end;
    if DP <> nil then Dispose(DP, Done);
    if BP <> nil then Dispose(BP, Done);
end.

```

Notice how the corresponding destructors in *Base.Init* and *Derived.Init* are used to reverse any successful allocations before *Fail* is called to finally fail the operation. Also notice that in *Derived.Init*, the call to *Base.Init* is coded within an expression so that the success of the inherited constructor can be tested.

## *New and modified error messages*

The following compiler error messages have been modified or added in Turbo Pascal 5.5.

### **24 File components may not be files or objects**

The component type of a file type cannot be an object type or a file type, or any structured type with an object type or file type component.

### **99 File and procedure types not allowed here**

A typed constant cannot be of a file or procedural type.

### **146 File access denied**

You are either trying to use a read-only file as an output file or trying to output to a directory name.

### **147 Object type expected.**

The identifier does not denote an object type.

### **148 Local object types are not allowed.**

Object types can be defined only in the outermost scope of a program or unit. Object type definitions within procedures and functions are not allowed.

**149 VIRTUAL expected.**

The reserved word **virtual** is missing.

**150 Method identifier expected.**

The identifier does not denote a method.

**151 Virtual constructors are not allowed.**

A constructor method must be static.

**152 Constructor identifier expected.**

The identifier does not denote a constructor.

**153 Destructor identifier expected.**

The identifier does not denote a destructor.

**154 Fail only allowed within constructors.**

The *Fail* standard procedure can be used only within constructors.

The following run-time error message has been added in Turbo Pascal 5.5.

**210 Object not initialized**

With range-checking on, you made a call to an object's virtual method, before the object had been initialized via a constructor call.



## Glossary

- ancestor type** Any type from which an object type inherits. The type named in an object type's definition statement is that type's immediate ancestor.
- binding** The process by which the caller of a procedure is given the address of the procedure. This can happen at compile/link time (*early binding*) or at run time, when the procedure is called (*late binding*). Traditional implementations of C and Pascal support only early binding; late binding is one of the major enhancements of object-oriented programming.
- constructor** A special method (defined with the reserved word **constructor**) that initializes an object containing virtual methods. Calling an instance's virtual methods without first calling its constructor generates a run-time error.
- descendant type** Any type that inherits from an object type. See *inheritance*.
- destructor** A special method (defined with the reserved word **destructor**) that determines the size of an object at run time and then deallocates the object from the heap. Destructors allow polymorphic objects to be deallocated correctly, even though their exact type (and hence exact size) is not known at compile time.
- early binding** A method of calling procedures in which the address to which control is passed is determined at compile/link time. Traditional C and Pascal compilers use only early binding.

- inheritance** The property of object types by which a type can be defined that includes all data and method definitions contained in a previously defined type, without restating those definitions.
- instance** A variable of an object type, as in "An instance of object type *Circle* is created on the heap." In most cases, the term *object* is used to mean an instance of an object type.
- late binding** A method of calling procedures in which the exact address to which control is passed is not determined until run time, when the call is actually made. Most object-oriented languages are capable of late binding. In conjunction with inheritance, late binding makes *polymorphism* possible.
- method** A procedure or function defined as belonging to an object type. There are two kinds, static methods and virtual methods.
- object** A variable of an object type. Sometimes called an *instance* of an object type.
- object hierarchy** A group of object types all related through inheritance. To see a graphic depiction of an object hierarchy, run Turbo Debugger on an object-oriented module and select the Hierarchy view from the Views menu.
- object type** A special data structure, similar to a Pascal record, that can contain definitions of procedures and functions, called methods, as well as data fields.
- polymorphic object** An instance of an object to which an object of a descendant type has been assigned. Turbo Pascal 5.5's assignment compatibility rules have been extended to allow such assignments; for example, if *Circle* is a descendant of *Point*, then variables of type *Circle* can be assigned to type *Point* (but not the reverse). The term is apropos since the polymorphic object can take on the "shape" of any of its descendant types. See *polymorphism*.
- polymorphism** From the Greek for "many shapes." As a consequence of inheritance and virtual methods, a single task (for example, redrawing to the screen) can be implemented using a common identifier (like *ReDraw*) and implemented differently as required for each type in an object hierarchy, as a virtual method. Later, when a polymorphic object (whose type is not known at compile-time) executes the *ReDraw* virtual method, the correct implementation is chosen and executed at run time.

- static method** A method implemented using early binding. The address of the method's implementation is determined at compile time, like the address of any ordinary procedure or function compiled under traditional Pascal. There is less overhead connected with a static method call, and static methods can be used as an optimization when the flexibility of virtual methods is not required.
- virtual method** A method implemented using late binding, by defining it with the new reserved word **virtual**. In practice, a virtual method shares an identical procedure or function header with one or more other methods within its object hierarchy. A special mechanism determines, at run time, which implementation of a virtual method should be called, depending upon the object type of the calling instance. This mechanism is put in place by calling an object's *constructor*.



\$ *See* compiler directives  
 @ (address operator)  
     with method designators 83

## A

abstract objects 39  
 activation, qualified 84  
 ancestors 9, 12, 70, 76, 115  
     assigning descendants to 32  
     immediate 12  
 arrays  
     range checking 73  
 assignment  
     compatibility 80, 83  
     statements 83

## B

/B command-line option  
     in TINST or INSTALL 3  
 binding  
     early 31, 115  
     late 31, 79, 115, 116  
         Turbo Debugger and 67  
         with polymorphic objects 38  
 Borland, contacting  
     CompuServe 4  
     mailing address 4  
 buffers  
     overlay 91  
         loading and freeing up 92  
         optimization algorithm 92  
         probationary area 93

## C

C++ 8  
 calling conventions  
     constructors and destructors 104

        methods 84, 104  
 case (reserved word)  
     statements 84  
 Change command (Turbo Debugger) 73  
 compatibility  
     assignment 80, 83  
     object 32, 33  
     parameter type 88  
     pointers to objects 33  
 compiler directives  
     \$L 105  
     \$R  
         virtual method checking 37, 101  
 computerized simulations 23  
 constants  
     typed  
         object type 82  
 constructor (keyword) 115  
 constructor (reserved word) 37, 75  
 constructors  
     calling conventions 104  
     declaring 85  
     defined 37, 86, 115  
     error recovery 108  
     implementation 85  
     inherited 79  
     virtual methods and 37, 51, 81, 86  
     VMTP and 99, 102  
 customer assistance 4  
 customizing *See* TINST

## D

data  
     objects  
         changing 73  
         inspecting 72, 73  
     structures  
         tracing through 73

- debugger, integrated *See* methods, debugging;
- objects, debugging
- debugging
  - methods *See* methods, debugging
  - objects *See* objects, debugging
- declaration
  - constructors 85
  - destructors 85
  - methods 15, 16, 78, 85
  - object instances 13
  - object types 76
- Descend command (Turbo Debugger) 73
- descendants 12, 70, 76, 115
  - immediate 12
- designators
  - field 19, 81
  - method 80, 81
    - @ (address operator) with 83
- destructor (keyword) 115
- destructor (reserved word) 75
- destructors 86
  - calling conventions 104
  - declaring 53, 85
  - defined 53, 86, 115
  - dynamic object disposal 54
  - implementation 85
  - polymorphic objects and 54
  - static versus virtual 53
- directives *See* compiler directives
- Dispose procedure
  - extended syntax 52, 101, 105
    - constructor passed as parameter 86, 88
- domain, object 76
- dotting 13, 17, 21
- dynamic object instances 50-62
  - allocation and disposal 55, 86, 104

## E

- early binding 31, 115
- encapsulation 9, 23
- error checking
  - dynamic object allocation 108
  - virtual method calls 101
- error messages
  - compiler 113
  - run-time 114
  - Turbo Debugger 74

- Evaluate window
  - calling methods in 69
    - objects and 66, 68
- event handling
  - virtual methods and 42
- exported object types 19
- extensibility 47, 80
- external (reserved word) 105

## F

- Fail procedure 109
- fields, object 13, 76
  - accessing 13, 16, 23
  - designators 19, 81
  - inherited 13
  - scope 17, 78, 85
    - method parameters and 19
- files
  - graphics, installing 3
    - obsolete, deleting 3
- Find Procedure command
  - methods and 66
- format specifiers
  - objects 66
- Function Inspector window (Turbo Debugger) 72
- functions
  - heap error 108
  - methods denoting 83
  - OvrGetRetry 93, 97
  - SizeOf 102
  - TypeOf 103

## G

- GRAPH.TPU
  - installed in a separate directory 3
- graphics
  - files, installed in a separate directory 3

## H

- heap error function 108
- hierarchies
  - object 12, 116
    - common attributes in 39, 42
  - tree 70
- Hierarchy command (Turbo Debugger) 72, 74

## I

- IDE *See* integrated development environment
- immediate ancestors and descendants 12
- implementation
  - constructors 85
  - destructors 85
  - methods 78, 85
- inheritance 9, 10, 11, 76, 116
  - showing during debugging 72, 73
- InitGraph procedure
  - path name to graphics directory 3
- Inspect command (Turbo Debugger) 70, 71, 72, 73
- INSTALL 2
  - /B command-line option 3
  - LCD or composite screen display
    - adjusting 3
- installing Turbo Pascal 2
- instances
  - defined 11, 116
  - dynamic object 50-62
  - object 79
    - declaring 13
    - linked lists of 55
  - static object 10-50
- integrated debugger *See* methods, debugging;  
objects, debugging

## L

- \$L compiler directive 105
- laptop computers
  - display, adjusting 3
- late binding 31, 79, 115, 116
  - Turbo Debugger and 67
  - with polymorphic objects 38
- LCD mode
  - display, adjusting 3
- linked lists 55

## M

- methods *See also* objects
  - activation, qualified 84
  - assembly language 18, 105
  - calling 15
    - as functions or procedures 83
    - conventions 84, 104

- debugging 65, 67
- declaring 15, 16, 85
- defined 14, 76, 116
- designators 80, 81
  - @ (address operator) with 83
- external 18, 105
- Find Procedure command and 66
- Function Inspector window 72
- identifiers, qualified 78
  - accessing object fields 21, 81
  - in method calls 80, 84
  - in method declarations 15, 16, 85
  - scope and 67
- implementation 78, 85
- inspecting 71-72, 73
- overridden, calling 84
- overriding inherited 25, 79
- parameters
  - naming 19
  - Self 17, 84, 85
    - debugging and 66, 68
    - defined 104
    - explicit use of 18
    - type compatibility 88
- positioning in hierarchy 42
- procedures versus 41
- qualified activation 84
- scope 17
- static 30, 79, 117
  - calling 80
  - problems with inherited 28
- virtual 30, 79, 117
  - calling 80, 84, 103
  - error checking 101
  - event handling and 42
  - polymorphic objects and 35
  - static versus 42
- methods. declaring 78
- Methods command (Turbo Debugger) 73

## N

- New Expression command (Turbo Debugger) 73
- New procedure 51
  - extended syntax 51, 101
    - constructor passed as parameter 86, 88, 104
    - used as function 52, 89

## O

- object (reserved word) 12, 75
- Object Hierarchy window (Turbo Debugger) 72, 69-74
- Object Instance Inspector window (Turbo Debugger) 72
  - array ranges 73
  - changing data values 73
  - methods and 73
- Object Type Inspector window (Turbo Debugger) 70, 71
  - complex data structures and 73
- objects *See also* methods
  - abstract 39
  - ancestor 12, 76, 115
  - constructors
    - declaring 85
    - defined 37, 86, 115
    - error recovery 108
    - implementation 85
    - inherited 79
    - virtual methods and 37, 51, 81, 86
    - VMTP and 99, 102
  - data
    - changing 73
    - inspecting 72, 73
  - debugging 65
    - Evaluate window and 66
    - stepping and tracing 65
    - Watch window and 66
  - defined 8, 116
  - descendant 12, 76, 115
  - destructors 86
    - declaring 53, 85
    - defined 53, 86, 115
    - dynamic object disposal 54
    - implementation 85
    - polymorphic objects and 54
    - static versus virtual 53
  - domain 76
  - dynamic instances 50-62
    - allocation and disposal 55, 86, 104
  - extensibility 47
  - fields 13, 76
    - accessing 13, 16, 23
    - designators 19, 81
    - inherited 13
    - scope 17, 78, 85
    - method parameters and 19
  - hiding data representation 24
  - hierarchies 12
    - common attributes in 39, 42
    - inspecting 69
    - tree 70
  - hierarchy 116
  - inheritance 76, 116
    - showing during debugging 72, 73
  - inspecting 71-72
  - instances 79
    - declaring 13
    - defined 116
    - linked lists of 55
  - internal data format 99
  - passed as parameters
    - compatibility 33
  - pointers to 80
    - compatibility 33
  - polymorphic 34, 80, 83, 88, 116
    - late binding and 38
  - relative position 62
  - static instances 10-50
  - Turbo Debugger and 67
  - typed constants of type 82
  - types 76, 116
    - compatibility
      - 32
    - declaring 76
    - exported by units 19
    - inspecting 71-72
    - list of 70
  - units and 19
  - virtual method table 101
    - pointer 99
    - initialization 37, 102
  - virtual methods
    - call error checking 101
    - calling 103
- Overlay unit 91
  - procedures and functions 93, 96
  - variables 94
- overlays
  - buffer 91
    - loading and freeing up 92
    - optimization algorithm 92



- probationary area 93
  - in .EXE files 97
  - load operations, customizing 95
  - manager 91
- overridden methods, calling 84
- overriding inherited methods 25, 79
- OvrGetRetry function 93, 97
- OvrSetRetry procedure 93, 97

## P

- parameters
  - method, naming 19
  - Self 17, 84, 85
    - debugging and 66, 68
    - defined 104
    - explicit use of 18
  - type compatibility 88
  - VMT 104
- pointers
  - assignment compatibility 80
  - to objects 80
- polymorphic objects 34
  - defined 116
  - late binding and 38
  - virtual methods and 35
- polymorphism 30, 32, 33
  - assignment compatibility 80
  - defined 116
  - object instance assignment 83
  - parameter type compatibility 88
  - pointer assignment 80
- probationary area, overlay buffer 93
- procedures
  - Dispose
    - extended syntax 52, 101, 105
      - constructor passed as parameter 86, 88
  - Fail 109
  - methods denoting
    - calls to 83
  - methods versus 41
  - New 51
    - extended syntax 51, 101
      - constructor passed as parameter 86, 88, 104
    - used as function 52, 89
  - OvrSetRetry 93, 97
  - statements 83

- programs
  - debugging *See* debugging

## Q

- qualified activation 84
- qualified method identifiers 78
  - accessing object fields 21, 81
  - in method calls 80, 84
  - in method declarations 15, 85
  - scope and 67

## R

- \$R compiler directive
  - virtual method checking 37, 101
- Range command (Turbo Debugger) 73
- records
  - types 11
- relative position 62
- reserved words
  - case 84
  - constructor 37, 75
  - destructor 75
  - external 105
  - object 12, 75
  - virtual 36, 75, 79
  - with 81, 84

## S

- scope, object fields and methods 17, 67
- Self parameter 17, 84, 85
  - debugging and 66, 68
  - defined 104
  - explicit use of 18
- Show Inherited command (Turbo Debugger) 72, 73
- Simula-67 23
- simulations, computerized 23
- SizeOf function 102
- Smalltalk 8, 23
- statements
  - assignment 83
  - case 84
  - procedure 83
  - with 13, 22, 81, 84
  - implicit 17
- static methods 30, 79, 117

- calling 80
- problems with scope of inherited 28
- static object instances 10-50
- Step Over command
  - methods and 65, 67

## T

- taxonomy 10
- technical support 4
- TINST
  - /B command-line option 3
  - LCD or composite screen display
    - adjusting 3
- Trace Into command
  - methods and 65, 67
- Tree command (Turbo Debugger) 70
- trees
  - object hierarchy 70
- Turbo Debugger *See also* methods, debugging;  
objects, debugging
  - Change command 73
  - Descend command 73
  - Function Inspector window 72
  - Hierarchy command 72, 74
  - Inspect command 70, 71, 72, 73
  - Methods command 73
  - New Expression command 73
  - Object Hierarchy window 72, 71-74
  - Object Instance Inspector window 72
  - Object Type Inspector window 70, 71
  - objects and *See* objects
  - Range command 73
  - Show Inherited command 72, 73
  - Tree command 70
- Turbo Pascal
  - installing 2
- typed constants
  - object type 82
- TypeOf function 103
- types
  - object 76, 116

- declaring 76
- exported by units 19
- record 11

## U

- /U command-line option
  - GRAPH.TPU file and 3
- Unit Directories command
  - GRAPH.TPU file and 3
- units
  - objects in 19
  - Overlay 91
- utilities *See* INSTALL; TINST

## V

- VER55 symbol 90
- virtual (keyword) 117
- virtual (reserved word) 36, 75, 79
- virtual method table 37, 101
  - pointer 99
    - initialization 37, 102
- virtual methods 30, 79, 117
  - calling 80, 84, 103
    - error checking 101
    - event handling and 42
    - polymorphic objects and 35
    - static versus 42
- VMT *See* virtual method table
- VMT parameter 104
- VMTP *See* virtual method table, pointer

## W

- Watch
  - window
    - objects and 66
- with (reserved word)
  - statement 13, 22, 81, 84
  - implicit 17